

Republic of South Africa

Project for the Promotion of Empowerment of  
Persons with Disabilities and Disability Mainstreaming

Project Completion Report

May 2020

Japan International Cooperation Agency

(JICA)

HM
JR
20-079

# Contents

## Contents

### Abbreviations and acronyms

1	Basic Information of the Project of the Project.....	5
1.1	Country.....	5
1.2	Title of the Project.....	5
1.3	Duration of the Project.....	5
1.4	Background.....	5
1.5	Overall Goal and Project Purpose.....	6
1.5.1	Overall Goal.....	6
1.5.2	Project Purpose.....	6
1.6	Implementing Agency.....	6
2.	Results of the Project.....	6
2.1	Results of the Project.....	6
2.1.1	Input by the Japanese side.....	6
2.1.2	Input by the South African side.....	8
2.1.3	Activities.....	9
2.2	Achievements of the Project.....	9
2.2.1	Outputs and indicators.....	9
2.2.2	Project purpose and Indicators.....	19
2.3	History of PDM Modification.....	21
2.4	Others.....	21
2.4.1	Results of Environment and Social Considerations.....	21
2.4.2	Results of Considerations on Gender/Peace Building/Poverty Reduction.....	21
3.	Results of Joint Review.....	21
3.1	Results of Review based on DAC Evaluation Criteria.....	21
3.1.1	Relevance.....	22
3.1.2	Effectiveness.....	25
3.1.3	Efficiency.....	26
3.1.4	Impact.....	27
3.1.5	Sustainability.....	28
3.2	Key Factors Affecting Implementation and Outcomes.....	30
3.3	Evaluation on the results of the Project Risk Management.....	31
3.4	Lesson Learnt.....	31
3.4.1	Understanding of government system.....	31
3.4.2	Examination of study site method.....	31

4. For the Achievement of Overall Goals after the Project Completion .....	32
4.1 Prospects to achieve Overall Goal .....	32
4.2 Plan of Operation and Implementation Structure of the South African side to achieve Overall Goal .....	34
4.3 Recommendations for the South African side.....	35
4.3.1 Obtainment of the Cabinet approval and circulation of the guidelines to stakeholders.....	35
4.3.2 Development of human resources .....	35
4.3.3 Discussion how to implement the DEM approach in the Respite Care programme	36
4.4 Monitoring Plan from the end of the Project to Ex-post Evaluation.....	36

Annex: DEM guidelines (including various materials and project activity's pictures)

## Abbreviations and acronyms

Abbreviations/acronyms	
CBID	Community-Based Inclusive Development Programme
CEG	Community-based Empowerment Group
CWP	Community Work Programme
CYCC	Child and Youth Care Centre
DEM	Empowerment of persons with disabilities and disability mainstreaming
DPI	Disabled Peoples' International
DPO	Disabled People's Organisation
DSD	Department of Social Development
EPWP	Expanded Public Works Programme
JCC	Joint Coordinating Committee
JICA	Japan International Cooperation Agency
M/M	Minutes of Meeting
NDP	National Development Plan
ODA	Official Development Assistance
PDM	Project Design Matrix
R/D	Record of Discussion
PO	Plan of Operation
SHG	Self-Help Group



## **1. Basic Information of the Project**

### **1.1 Country**

The Republic of South Africa

### **1.2 Title of the Project**

Project for the Promotion of Empowerment of Persons with Disabilities and Disability Mainstreaming

### **1.3 Duration of the Project**

9 May 2016 – 8 May 2020

### **1.4 Background (from Record of Discussions(R/D))**

The Government of the Republic of South Africa has been striving to reduce poverty and inequality since the advent of democracy in 1994. Various policies and legislations ensure equal distribution of benefits of economic and social developments. Yet, the country continues to face persistent or even widening inequality. Particularly, persons with disabilities remain uneducated, unskilled, unemployed and as a results, the poorest of the poor. South Africa has ratified the United Nations Convention on the Rights of Persons with Disabilities (CRPD) in 2007. However, there are still a lot to be done to implement the CRPD and other disability related policies for practical realisation of the rights of persons with disabilities in South Africa.

Department of Social Development (DSD) is at the forefront of delivering basic social services to persons with disabilities, in collaboration with other key departments. Despite a comprehensive policy framework, effective implementation of existing policies and standards remains problematic. Limited access to development hinders active participation of persons with disabilities. There is a lack of institutional capacity to plan, budget, implement and monitor disability-inclusive programmes through the empowerment of persons with disabilities in a cross-sectoral manner. Data and information about the challenges faced by persons with disabilities in different parts of the country is seriously lacking. This prevents DSD officials from delivering appropriate support based on the system for disability mainstreaming which hampers sound programme implementation as well as organisational learning.

In this regard, since 2012, Japan International Cooperation Agency (JICA) has dispatched an advisor on disability mainstreaming and assisted national and province DSD officials in facilitating a series of training at the national and provincial level. This was done through knowledge and skills development by DSD officials to effectively mainstream disability and the empowerment of persons with disabilities. With the technical advice by the JICA advisor, DSD conducted Monitoring and Evaluation (M&E) by following up action plans developed by the participants in the training to ensure the implementation of community-based activities and identification of ‘good practice’ on disability

mainstreaming in provinces. The M&E also contribute to the profiling and analysis of the situation concerning disability mainstreaming and empowerment of persons with disabilities through the documentation of ‘good practice’. However, DSD faces challenges in further strengthening their capacities in the implementation of empowerment of persons with disabilities and disability mainstreaming at local level.

DSD in this regard, submitted an application for the Project for the Promotion of Empowerment of Persons with Disabilities and Disability Mainstreaming (the Project) to the Government of Japan. And the latter adopted the application in March 2015.

**1.5 Overall Goal and Project Purpose (from Record of Discussions(R/D))**

**1.5.1 Overall Goal**

Empowerment of persons with disabilities and disability mainstreaming in South Africa are promoted through collaboration by DSD and the resources developed by the Project.

**1.5.2 Project Purpose**

Capacities of DSD in empowerment of persons with disabilities and disability mainstreaming are enhanced.

**1.6 Implementing Agency**

Department of Social Development (DSD) (National, Provinces, Districts)

**2. Results of the Project**

**2.1 Results of the Project**

**2.1.1 Input by the Japanese side**

1) The number of dispatched Japanese experts: 4 people

A total of three long-term experts and one short-term expert were dispatched to DSD for implementing the Project.

Table 2-1: List of Japanese experts

Type of expert	Specialty	Name	Period
Long-term expert 1	Chief Advisor / Disability Mainstreaming	Mr. Daisuke Sagiya	9 <sup>th</sup> May 2016 - 8 <sup>th</sup> May 2019
Long-term expert 2	Chief Advisor / Disability Mainstreaming	Ms. Maho Harada	22 <sup>nd</sup> April 2019 - 8 <sup>th</sup> May 2020
Long-term expert 3	Empowerment of Persons with Disabilities / Project Coordinator	Mr. Ren Kamioka	9 <sup>th</sup> May 2016 - 8 <sup>th</sup> May 2020
Short-term expert 1	Establishment and Strengthening of Self-Help Group of Persons with Disabilities	Mr. Yutaka Takamine	21 <sup>st</sup> July – 3 <sup>rd</sup> August 2017

2) Participants of training in Japan: 35 people  
 35 stakeholders participated in the trainings as below.

Table 2-2: Training in Japan

Country-focused training: 2 times (Total participants are 25 people)

Name of training course	Date	Number of participants
Establishment and Strengthening of SHG of Persons with Disabilities through Community-Based Inclusive Development (CBID)	26 <sup>th</sup> Nov - 9 <sup>th</sup> Dec 2017	15 people in Site 1, 3 (and 3 personal assistants (PA))
Promoting Disability Empowerment and Mainstreaming approach towards CBID	2 <sup>nd</sup> - 15 <sup>th</sup> Dec 2018	10 people in Site 2,4 (and 4 PA)

Group and Region focused training: 8 times (Total participants are 10 people)

Name of training course & Number of participants	Date	Participant information
Development of Leadership & Networking of persons with disabilities	28 <sup>th</sup> Sep - 16 <sup>th</sup> Nov 2016	1 person (a person with visual impairment. Limpopo)
Improvement of Accessibility for Social Inclusion	20 <sup>th</sup> June - 8 <sup>th</sup> July 2017	1 person (a wheelchair use, Free State) (and 1 PA)
Capacity Development of Leaders with Disabilities for UNCRPD	27 <sup>th</sup> Sep - 9 <sup>th</sup> Nov 2017	1 person (a person with Albinism, Free State)
Social Participation and Livelihood of Persons with Disabilities through a CBID Approach	10 <sup>th</sup> Jan - 17 <sup>th</sup> Feb 2018:	1 person (a person with visual impairment, chief directorate of community development, DSD) (and 1 PA)
Social Participation and Livelihood of Persons with Disabilities through a CBID Approach	22 <sup>nd</sup> Aug - 29 <sup>th</sup> Sep 2018:	1 person (a parent of children with disability, Disabled Children Action Group, (KZN)
Promoting Independent Living through Empowerment of Persons with Disabilities in Africa	18 <sup>th</sup> Aug - 13 <sup>th</sup> Sep 2019	2 people (persons with physical disabilities, Free State & Eastern Cape) (and 1 PA)
Capacity Development of Leaders with Disabilities for UNCRPD	6 <sup>th</sup> Nov - 14 <sup>th</sup> Dec 2019	1 person (a person with Albinism, Eastern Cape)
Social Participation and Livelihood of Persons with Disabilities through a CBID	15 <sup>th</sup> Jan - 22 <sup>nd</sup> Feb 2020	2 people from KZN province (an official of iLembe district DSD and a deputy chairperson of disability forum of Mandeni municipality)

### 3) Provision of equipment

Project office equipment was provided with the total amount of estimated cost of the equipment is R 117,810.00 (R58,905.00 x 2 sites). The equipment was used for the Project activities in the Project term and handed over to Site 1 and 2 in order to sustain the DEM activities. Main users are the working group members with disabilities who implement the DEM activities. DSD Provinces are coordinating to manage the equipment such as an office for keep the equipment, maintenance ways of the equipment, users of the equipment etc. The list of office equipment provided is shown in Table 2-3.

Table 2-3: List of provided office equipment (per site)

Description	Estimated cost
All in one printer (CANON MF628Cw)	R4,499.00
Cartridge for the printer (CANON 731)	R7,995.00
Air cooler (LOGIK)	R1,099.00
Heater (SUNBEAM: Model SBH-6000)	R1,199.00
Stationary (extension cable, stapler, etc.)	R775.00
Projector (ACER: X125H DLP Projector)	R6,499.00
Screen (ULTRALINK: UL-TS004N)	R1,199.00
Laptop (DELL: Latitude E7270 CTO)	R35,640.00
Total	R58,905.00

Note: Project vehicle and multi-function printer are not included since these will be used by the individual expert who will be dispatched to DSD in 2020.

#### 4) Local operational cost borne by Japanese side (from April 2016 to March 2020)

By the end of March 2020, a total of 416 million Rand was disbursed as the operational costs for the project activities. The local operational cost mainly consisted of cost for training costs in the project study sites, travel expenses, development costs of guidelines, communication expenses, fuel expenses, etc. The details of operational cost as per financial year (FY) are shown in Table 2-4.

Table 2-4: The details of the local operational cost as per FY

FY	Items	Amount (Rand)
2016	Project vehicle and project activities	1,403,126.18
2017	Project activities	770,129.00
2018	Project activities	858,755.78
2019	Development of guidelines and project activities	1,059,133.41
Plan for 2020	Modification of guidelines	70,000.00
Total		4,161,144.37

#### 2.1.2 Input by the South African side

##### 1) Personnel of DSD for the Project: 8 people

Four officials of national DSD and four officials of provincial/district DSDs in Site 1 and 2 worked for the Project as the counterparts. (The list of Japanese and South African sides personnel including personnel in Site 1-4 is included as Annex 1.)

Table 2-5: List of DSD Personnel

Title	Name	Position in the JCC
Deputy Director-General of Right of persons with disabilities, National DSD	Mr Mzolisi Toni	Project Director
Director of Directorate, Services to persons with disabilities, National DSD	Ms Manthipi Molamu	Project Manager
Deputy Director of Directorate, Services to persons with disabilities, National DSD	Mr Krish Shunmugam	Project Sub Manager
Senior Administrator, Services to persons with disabilities, National DSD	Mr Chris Bame	JCC members

Province and District DSD officials in the project sites <ul style="list-style-type: none"> <li>• Limpopo province: 1 provincial disability coordinator and 1 district disability coordinator</li> <li>• Free State province: 1 provincial disability coordinator and 1 district disability coordinator</li> </ul>	JCC members
--	-------------

2) Provision of office space etc.

- The office for single occupancy.
- Laptops, computer screens, key boards and office telephones were provided for each expert.
- Parking spaces were provided for each expert.

3) Others

- Travel expenses for the government officials (accommodation, S&T, transport)
- Travel expenses for the participants of the project completion seminar (transport)

Some cases following were provided:

- Catering and venue fee for Joint Coordinating committee meeting
- Catering fee and transport for the project activities
- Domestic travel expenses for participants of the training in Japan (accommodation, transport)

2.1.3 Activities

On the whole, the planned activities were almost implemented. The details of the implementation of activities are mentioned in the following item: “2. Achievements of the Project”.

**2.2 Achievements of the Project**

2.2.1 Outputs and Indicators

**Output 1: The information of situation and resources for the empowerment of persons with disabilities and disability mainstreaming in South Africa is managed in DSD.**

The output 1 has almost been achieved for managing the information and the resources in DSD. Considering the achievement as per indicators, the indicator 1.2 will be not able to achieve completely before the Project completion due to the national lockdown to contain the spread of the novel coronavirus in South Africa from 27 March.

The developed guidelines plans to be saved in the database system of the national DSD: “Intranet: the knowledge hub that keeps DSD working”. But, it cannot be handled before the Project completion because the final draft guidelines are not be approved yet by the Cabinet due to the coronavirus lockdown. DSD continues to address this task after the Project completion. The achievement as per each indicator is described Table 2-6.

Table 2-6: Achievements of Output 1 and related activities

Indicator	Achievement
1.1 Baseline information of empowerment of persons with disabilities and disability mainstreaming in South Africa and the study sites are identified and set.	<ul style="list-style-type: none"> <li>- The basic information (such as number of persons with disabilities in each province) was identified by utilising the Census 2011 and Community Survey 2016 by Statistics South Africa.</li> <li>- The baseline information in site 1 (Limpopo) and site 2 (Free State) was collected and analysed. The results of the baselines survey were shared in the JCCs (Mar 2017 &amp; Mar 2019).</li> </ul>
1.2 The information of persons with disabilities' social participations and the resources for empowerment of persons with disabilities and disability mainstreaming in South Africa is integrated into the database.	<ul style="list-style-type: none"> <li>- The DEM project folder was created in shared folder of the Branch of Rights of Persons with Disabilities, national DSD, and all information on the Project was saved into the folder. (see to Diagram 2-1)</li> <li>- The guidelines which were developed based on the project experiences and information collected by the Project will be saved in the database system of the national DSD: "Intranet: the knowledge hub". (see to Diagram 2-2)</li> </ul>



Diagram 2-1: Web site "Intranet: the knowledge hub"

1. RD, MM\_20121214
2. JCC
3. DEM Guidelines Seminar
4. DEM Guidelines
5. Monitoring Sheet
6. Project Completion Report
7. APP Quarterly Report\_FY 2019
8. Trip Report
9. Project News Letter
10. Office Equipment for National DSD, Site 1,2
11. Results of Baseline Survey in Site 1,2,3,4
12. Training in Japan
13. JICA HQ Mission to SA
14. CPD Application\_DEM Training
15. Contact List
16. Others

Diagram 2-2: Information saved in the folder "Branch of Rights of Persons with Disabilities"

The activities 1-1, 1-2, 1-3, 1-4 and 1-5 for Output 1 have been implemented to identify and set the information of empowerment of persons with disabilities and disability mainstreaming, and integrate it into the database. Those activities are:

- 1-1 Establish the Working Groups and confirm their terms of references
  - 1-2 Collect the baseline information of the empowerment of persons with disabilities and disability mainstreaming with particular focus to study sites
  - 1-3 Analyse the collected information
  - 1-4 Compile the collected and analysed information and create the database for resources
- Update the database according to the activities of Output 2, 3 & 4.

In Site 2, “Activity 1-1” is not achieved yet completely. Persons with disabilities and district DSD official established a technical team voluntarily. However, they need more involvement of different district departments (such as Department of Basic Education, Department of Health, Department of Public Works, municipalities, etc.) and provincial DSD to accelerate the activities. Stakeholders discussed this issue and agreed on the necessity of the working group composing of the technical team members and officials of key departments, but the working group still does not be confirmed yet for its establishment. The reasons behind are: 1) no smooth relationship among relevant persons in the site; and 2) insufficient of coordination and commitment of provincial/district officials. However, establishment of the working group is agreed by stakeholders, and district DSD is coordinating for establishment of the working group in consultation with provincial DSD. On the other hand, since the Project team approached individuals in Site 2 and they implemented the activities, Activity 1-2, 1-3 and 1-4 have been achieved by national DSD in collaboration with the Project team.

However, if the working group is not established, it is difficult to sustain the activities. For sustainability, importance of working group should be emphasised. To emphasise its importance, the guidelines developed by the Project show: 1) importance of the working group; 2) each role of different levels at province, district and the study site; 3) importance of common understanding among the different levels organisations.

**Output 2: Approaches for implementing empowerment of persons with disabilities and disability empowerment are developed by DSD.**

Approaches for implementing empowerment of persons with disabilities and disability empowerment were developed by DSD, and the guidelines were completed for implementing the approaches. Thus the output 2 has been achieved. The achievement as the indicator is show in Table 2-7.

Table 2-7: Achievements of Output 2 and related activities

Indicator	Achievement
2.1 Production material of 'Approaches for empowerment of persons with disabilities and disability mainstreaming in completed.	<ul style="list-style-type: none"> <li>- The approaches have been developed based on the project experiences.</li> <li>- The final draft DEM guidelines as production material of the approaches have been completed in April 2020.</li> <li>- The guidelines plan to be submitted to the Cabinet in May 2020, and be approved officially.</li> <li>- The guidelines will be circulated to all provincial DSDs and key stakeholders after the Cabinet approval.</li> </ul>

The activities 2-1, 2-2, 2-3, 2-4, 2-5 and 2-6 for Output 2 have been implemented to complete production material of the approaches. These activities are:

- 2-1 Working Groups develop a plan to formulate the approaches
- 2-2 Implement the planned activities
- 2-3 Conduct collection and analysis of the results and process of the implementation of activities
- 2-4 Prepare draft guidelines based on the results of the activities the approaches are compiled in documents as guidelines
- 2-5 'Approaches for empowerment of persons with disabilities and disability mainstreaming' are compiled in documents (e.g. guidelines)
- 2-6 Apply the first edition of the guidelines and make necessary modification on them.

The guidelines were developed based on the experiences and lessons learnt from activities in the four study sites include:

- Site 1: Collins Chabane municipality, Vhembe district, Limpopo province
- Site 2: Maluti-a-Phofung municipality, Thabo Mofutsanyana district, Free State province
- Site 3: Nyandeni municipality, OR Tambo district, Eastern Cape province
- Site 4: Mandeni municipality, iLembe district, KwaZulu-Natal province

The Project was started in Site 1 from May 2016, while Site 2 began in 2017 based on the collective experience of the activities at Site 1. The first edition of the guidelines was developed from the lessons learnt in the activities at Sites 1 and 2, in March 2019. From April 2019, the Project was rolled out to Sites 3 and 4. The first edition of the guidelines were then utilised for activity implementation at these sites to validate usability and effectiveness. Finally, the final draft of the guidelines were completed in April 2020 based on the lessons learnt in the project activities from 2016 to 2020 at all four study sites. The guidelines will be finalised by the Cabinet approval, and circulated to key stakeholders.



Title of the guidelines is "Guidelines on Services to Persons with Disabilities for Empowerment of Persons with Disabilities and Disability Mainstreaming at District level (DEM guidelines)". The guidelines align with "Policy on Social Development Services to Persons with Disabilities", District Development Model and other relevant policies. The DEM approach values district governments, municipalities and persons with disabilities together develop an activity plan and implement the developed plan. National and provincial governments and DPOs support and monitor these activities. Thus, the DEM approach aligns with the District Development Model.

Overview of the DEM approach and the guidelines is as follows. It is excerpted from the Executive Summary in the DEM guidelines.

\*\*\*\*\*  
The empowerment of persons with disabilities and disability mainstreaming (DEM) approach is a way to empower persons with disabilities and create a platform for persons with disabilities, governments, municipalities and other key stakeholders for the realisation of the participation of persons with disabilities in the mainstreaming at district and local level.

The aim of the DEM guidelines is to explain how to implement the DEM approach, in six parts. Part 1 introduces the background of the guidelines which have been developed through a four-year international technical cooperation project between DSD and JICA, called 'Promotion of Empowerment of Persons with Disabilities and Disability Mainstreaming', from May 2016 to May 2020. The guidelines were developed based on the experiences and lessons learned in activities in the four project study sites in four different provinces: Limpopo, Free State, Eastern Cape and KwaZulu-Natal.

Part 2 defines and clarifies the DEM approach by its central concept. The DEM approach shows how persons with disabilities can and do participate in the implementation of disability mainstreaming at district and local level. In addition, the DEM approach emphasises that persons with disabilities and their families should first be empowered in order to realise their active participation in disability mainstreaming, and create a platform for persons with disabilities, governments, municipalities and other key stakeholders.

The concept behind the DEM approach rests on three fundamental principles: 1) putting persons with disabilities and their families first and centre; 2) developing government capacity and systems; and 3) creating inclusive communities through practical activities. (Three fundamental principles in concept of the DEM approach are show in Diagram 2-3.)



Diagram 2-3: Three fundamental principles in concept of the DEM approach

Part 3 explains how to implement the DEM approach by showing the implementation steps of the DEM approach. The implementation steps can be described in the following six steps:

- Step 1: Create a platform at district level to obtain buy-in from key stakeholders
- Step 2: Establish a working group at local municipality level to guide and oversee the implementation process
- Step 3: Conduct training to empower the working group
- Step 4: Conduct a baseline survey, and develop an activity plan based on results of the survey
- Step 5: Implement planned activities by the working group
- Step 6: Monitor and evaluate in collaboration with three spheres of government and DPOs

(The DEM implementation steps are show in Diagram 2-4.)



Diagram 2-4: Six steps of the DEM implementation steps

In Part 3, a range of concrete practical activities is shown as references for the DEM approach to implement including: establishing a working group; capacity building training; conducting a baseline survey, developing an activity plan at DEM introductory workshop, etc. As useful references to implement each practical activity, training facilitation guides, workshop presentation slides, and other materials are included in this book as Tools 1–15.

An important reminder is that at every step of this process, persons with disabilities and their families are to be placed first and centre, and should be active members of all discussions, decisions and activities.

In Part 4, the specific resources required are listed, including human resources and financial resources. Adequate and appropriate resource allocation is a critical factor for the success of continuous implementation of the planned activities.

Part 5 introduces the good practice that is used in the DEM approach, such as disability mainstreaming in various directorates in DSD, different departments and sectors, and collaboration with municipalities.

Part 6 summarises the five key elements of the DEM approach, as follows:

- Persons with disabilities and their families should be first and centre in all processes and activities
- It is a principle to capacitate and empower persons with disabilities first to enable their active participation in activities
- Another principle is to establish a working group consisting of persons with disabilities, governments, municipalities and other key stakeholders; this enables them to work together as equals in a team
- The working group develops an activity plan to address barriers faced by persons with disabilities in the implementation site
- Activities are implemented in communities at local municipality level in collaboration with national, provincial and district governments.

(The final draft of DEM guidelines is included as Annex 2.)

**Output 3: Resources (human resources, relevant organisations, partnerships etc.) are strengthened for empowerment of persons with disabilities and disability mainstreaming.**

The output 3 has been achieved for strengthening the resources. The target for the indicators of Output 3 has been set in a quantitative way, and the achievement as per each indicator is shown in Table 2-8.

Table 2-8: Achievements of Output 3 and related activities

Indicator	Achievement
<p>1) Certificated human resources by the Project: at least 30 persons</p>	<p><u>46 persons</u> (certified human resources) were developed as follows; (The list of certificated human resources is included as Annex 1.)</p> <ol style="list-style-type: none"> <li>1) 29 persons with disabilities <ul style="list-style-type: none"> <li>- 8 peer counsellors</li> <li>- 11 disability awareness facilitators</li> <li>- 10 access auditors</li> </ul> </li> <li>2) 6 trainers for training <ul style="list-style-type: none"> <li>- 2 trainers for peer counsellor training</li> <li>- 2 trainer for disability awareness facilitator training</li> <li>- 2 trainers for access auditor training</li> </ul> </li> <li>3) 7 government officials at provincial and district level <ul style="list-style-type: none"> <li>- 5 provincial and district DSD disability coordinator</li> <li>- 1 special unit officer of district municipality</li> <li>- 1 councillor</li> </ul> </li> <li>4) 4 government officials at national level <ul style="list-style-type: none"> <li>- 4 officials of the national DSD (DDG, Director of the Directorate, Deputy Director of the Directorate and a focal official of disability mainstreaming in children unit)</li> </ul> </li> </ol> <p>Note: “Certificated” human resources by the Project are persons who meet the following requirements.</p> <ul style="list-style-type: none"> <li>- Participated in the trainings fully</li> <li>- After the trainings, conducted practical activities with utilising knowledges and skills obtained in the trainings at least one time.</li> </ul>
<p>2) Types and number of materials developed: at least 3</p>	<p><u>4 training materials</u> were developed as follows; (These materials are included as Annex 2: DEM guidelines.)</p> <ul style="list-style-type: none"> <li>- Materials for DEM introductory workshop</li> <li>- Training materials for peer counsellor training</li> <li>- Training materials for disability awareness facilitator training</li> <li>- Training materials for access auditor training</li> </ul>
<p>3)-1 The number of activities jointly coordinated by DPOs and</p>	<p><u>More than 10 collaborated activities</u> were done in the study sites as follows; (These materials are included as Annex 2: DEM guidelines.)</p> <ul style="list-style-type: none"> <li>- Activities by persons with disabilities in villages (disability awareness activities and peer counselling) in collaboration with DSDs and municipalities. (Site 1 and 2)</li> <li>- Access audit by persons with disabilities in collaboration with DSDs,</li> </ul>

provincial DSDs/ district DSDs/ municipalities is increased: 8	municipalities, Department of Public Works, schools and others. (Site 1 and 2) <ul style="list-style-type: none"> <li>- Increased learnerships participation of persons with disabilities through collaboration with municipalities, DSDs and persons with disabilities. (Site 1 and 2)</li> <li>- Media forum in collaboration with radio stations, persons with disabilities and DSDs. (Site 1)</li> <li>- Support services and events for persons with disabilities by DPOs in collaboration with DSDs. (Site 1, 2, 3)</li> </ul>
3)-2 The number of intra-department collaborations/ programmes on disability developed by the Project is increased: 4	<u>7 collaborated activities</u> were done as follows; <ul style="list-style-type: none"> <li>- An official, branch of community development of the national DSD participated in the training in Japan, and developed community development guidelines. (1)</li> <li>- Disability mainstreaming in Directorate of children’s services, national DSD (1)             <ul style="list-style-type: none"> <li>• Sensitisation session on disability mainstreaming at provincial children coordinators meeting</li> <li>• Knowledge sharing meeting on disability mainstreaming for officials in Directorate of children’s services, national DSD</li> </ul> </li> <li>- Disability mainstreaming training was organised for stakeholders of Child and Youth Care Centre in collaboration with the directorate of children’s services and provincial/district DSDs. (1)</li> <li>- Knowledge sharing meeting on disability mainstreaming was held for officials in Directorate of HIV/AIDS of the national DSD. (1)</li> <li>- DSD Limpopo province organised a DEM project seminar for provincial officials. As outcomes of the seminar, the children unit, family unit and HIV/AIDS unit invited children with disabilities and their families to their events. (3)</li> </ul>

The activities 3-1, 3-2 and 3-3 for Output 3 have been implemented to develop the resources and collaboration activities. These activities are:

3-1 Working Groups design a plan for development of the resources

3-2 Develop the resources in cooperation with relevant organisations

3-3 Monitor the activities effects through collaboration with relevant organisations, and feedback to the activity plan.

The working group identified needs of persons with disabilities in the study site based on results of the baseline survey. They developed an activity plan to address these needs and implemented the planned activities. Examples of the implemented activities were peer counselling, establishment of

community-based empowerment group (CEG: alternative name of Self-Help Group), disability awareness activities, access audits, etc. Firstly, required human resources and materials were developed to implement these activities, and then the practical activities were implemented.

The CEG was established in Site 1. Through peer counselling, persons with disabilities recognised importance of activities with peer (persons with disabilities), and they established the CEG. On the other hand, in Site 2-4, members of existing DPOs joined the DEM project as the working group. They did not have the needs of establishment of the CEG, but they utilised knowledges and skills acquired in the Project for their existing groups.

Disability awareness activity aims to understand social model of disability, based on Disability Equality Training (DET). It simplified the DET. The DET composes of two parts. One is the understanding of the social model through simple exercises. The other is making an action plan to create inclusive society and environment. The disability awareness activity implements the first half of activities of the DET, i.e. understanding of the social model by the five exercises. In the Project, persons with disabilities who implement the disability awareness activity are called "disability awareness facilitators". They are trained in Disability Awareness Facilitator Training.

The experiences of development of the resources and collaboration activities, and developed materials were reflected and included in the guidelines so that other provinces and districts can refer to these experiences.

**Output 4: Functions of DSD to collaborate and coordinate with relevant organisations of the neighbouring countries for empowerment of persons with disabilities and disability mainstreaming are strengthened.**

The output 4 has been achieved for strengthening the functions of DSD to collaborate and coordinate with relevant organisations of the neighbouring countries. The achievement as per each indicator is described Table 2-9.

Table 2-9: Achievements of Output 4 and related activities

Indicator	Achievement
4.1 The number of times that the project newsletters are issued to share about experiences in empowerment of persons with disabilities and disability mainstreaming; at least 2 times per year	The newsletters (English/Japanese) were issued 14 times.
4.2 70% of the participants and satisfied with seminars/trainings/workshops/newsletters/Facebook (contents, trainers etc.)	Questionnaires on feedback of newsletters/Facebook were conducted for relevant persons in the neighbouring. – 100 % respondents satisfied with newsletter, 71 % respondents satisfied with Facebook.

The activities 4-1, 4-2 and 4-3 for Output 4 have been implemented to share about the project experiences with relevant organisations of the neighbouring countries, and confirm their satisfaction about newsletters and Facebook. These activities are:

- 4-1 Invitations is extended to the participants from neighboring countries to the events (seminar, training, etc.)
- 4-2 Collect the information of current situation on empowerment of persons with disabilities and disability mainstreaming in the neighbouring countries
- 4-3 Share the information of situation and knowledge on empowerment of persons with disabilities and disability mainstreaming.

In October 2018, four delegates from Eswatini Deputy Prime Minister's Office visited the site 1. They understood outline of the Project, particularly community-based activities by presentation of persons with disabilities. In October 2019, the national DSD sent invitation letter to relevant ministry in Lesotho to invite disability mainstreaming training in Site 2 (Unfortunately, they did not participate in the training because it was short notice). (The list of oversea trip is included as Annex 1.)

According to the results of the questionnaires on feedback of newsletters and Facebook, most respondents provided positive feedback and expect that similar project will be implemented in their countries. (The project news letters are included as Annex 2.)

2.2.2 Project Purpose and Indicators

**Project Purpose: Capacities of DSD in empowerment of persons with disabilities and disability mainstreaming are enhanced.**

The project purpose has been achieved for enhancing capacities of DSD in empowerment of persons with disabilities and disability mainstreaming, by showing the clear accomplishment of the indicators. The achievement as per each indicator is described Table 2-10.

Table 2-10: Achievements of Project Purpose as per indicator

Indicator	Achievement
1. The activity plan is formulated utilizing the developed ‘Approaches’ and ‘Resources’ for empowerment of persons with disabilities and disability mainstreaming.	<p><u>DEM approach has been included in annual performance plan (APP) of the national DSD</u></p> <ul style="list-style-type: none"> <li>– DEM approach was included in 2019/20 APP of the national DSD.</li> <li>– In 2020/21 APP, the national DSD will implement a pilot project for Respite Care programme in two provinces, incorporating the DEM approach.</li> </ul>
2. DSD applies ‘Approaches for	<p><u>DSD commenced the DEM approaches in three districts.</u></p> <ul style="list-style-type: none"> <li>– Activities using the DEM approaches were commenced in three</li> </ul>

empowerment of persons with disabilities and disability mainstreaming' in at least 2 districts.	<p>districts: 1) OR Tambo district, Eastern Cape; 2) iLembe district, KZN; and 3) Mopani district, Limpopo.</p> <p>– DSD Limpopo province conducted disability mainstreaming training at all five districts, using the DEM approach and resources developed by the Project.</p>
---	---

DEM approach was included in 2019/20 APP of the national DSD for developing Community-Based Inclusive Development Programme (CBID). The operational plan is as follows;

Table 2-11: Quarterly activities of CBID programme in Operational plan

Annual target: CBID Programme is developed.

Quarter	Activities
Q1	DEM approach developed and implemented in Limpopo and Free State
Q2	DEM approach developed and implemented in Eastern Cape and KZN
Q3	Draft guidelines on DEM approach towards CBID developed
Q4	Guidelines on DEM approach towards CBID approved

DEM approach was included in 2019/20 APP of the national DSD for developing Community-Based Inclusive Development Programme (CBID). The operational plan is as follows;

In 2020/21 APP, the national DSD will implement a pilot project for Respite Care programme in two provinces, incorporating the DEM approach. The operational plan is as follows;

Table 2-12: Quarterly activities of Respite care programme in Operational plan

Annual target: Guidelines on Respite care services to families and persons with disabilities are piloted in two Provinces and updated.

Quarter	Quarterly target	Activities
Q1	Partnership programme with 2 provincial DSD, 2 national departments and 2 DPO in the Piloting of the Respite care programme is established.	<ul style="list-style-type: none"> <li>– Selection of the 2 pilot sites is facilitated.</li> <li>– Implementation team is established.</li> </ul>
Q2	Draft pilot reports are developed.	<ul style="list-style-type: none"> <li>– Partnership programme &amp; log frame are developed, costed and implemented.</li> <li>– DEM approach is implemented.</li> </ul>
Q3	Draft pilot reports are developed.	<ul style="list-style-type: none"> <li>– Appointment of a service provider to update the Guidelines</li> <li>– Facilitate development of the progress reports.</li> </ul>
Q4	Guidelines on Respite care services to families and persons with disabilities are updated & finalised. Consolidated report is developed.	<ul style="list-style-type: none"> <li>– Guidelines are circulated for inputs &amp; updated.</li> <li>– Approval of the guidelines</li> </ul>



## 2.3 History of PDM Modification

PDM was revised four times and approved in the Joint Coordinating Committee (JCC). All PDM (version 0 – 4) are attached as Annex 3. The list of the revision of PDM is shown in Table 2-13.

Table 2-13: List of the revision of PDM

PDM ver.	Date	Part of revision	Reason for revision
0	Dec. 2015 by R/D	-	
1	1 <sup>st</sup> JCC in July 2016	a) Name of study sites b) Input	a) Added names of municipalities as the study sites since the municipalities were identified. b) South African side suggested that for inputs of human resources, preference should be given to local experts in South Africa.
2	2 <sup>nd</sup> JCC in March 2017	c) Indicators of Overall Goal d) Indicators of Outcome 3	a) Determined the percentage regarding the indicator of Overall goal b) Determined the number regarding the indicator of Output 3
3	5 <sup>th</sup> JCC in March, 2019	a) Activity 2-6 b) Indicator of Outcome 4	a) Changed from “the guidelines” to “the first edition of the guidelines” b) Added “newsletters/Facebook” besides seminars/workshops/ trainings
4	6 <sup>th</sup> JCC in March, 2020	Indicator of Overall Goal	Defined scope of the target group and activities to make clear necessary information for measuring the indicators.

## 2.4 Others

### 2.4.1 Results of Environmental and Social Considerations (if applicable)

Not applicable

### 2.4.2 Results of Considerations on Gender/Peace Building/Poverty Reduction (if applicable)

In the selection process of the working group members and the participants of the training in Japan, etc., gender was seriously considered. For instance, 23 female and 23 male human resources were developed and certificated by the Project.

## 3. Results of Joint Review

### 3.1 Results of Review based on DAC Evaluation Criteria

The JICA adopted the Five DAC (Development Assistance Committee) Evaluation Criteria for project evaluation. The five criteria are namely:

- **Relevance:** A criterion for considering the validity and necessity of the Project regarding: whether the project purpose meets with the needs of target group; whether the contents of the Project is consistent with policies; whether the project strategies and approaches is appropriate as a solution

for problems concerned.

- Effectiveness: A criterion for considering whether the project activities and outputs has benefited the target group, and achieve the project purpose.
- Efficiency: A criterion for considering how economic resource/inputs are converted to results.
- Impact: A criterion for considering the effects of the Project with an eye on the longer term effects including direct or indirect, positive or negative
- Sustainability: A criterion for considering whether produced effects continue after the termination of the Project.

### 3.1.1 Relevance: High

The Project is well aligned with the South African policies on the services to persons with disabilities and national policies such as the national development plan 2030 (NDP) as well as with Japan's official development assistance (ODA) policy towards South Africa. It is also responding to the needs for persons with disabilities at local level. The approach of the Project was to utilise Japan's comparative advantages in the area of experience of empowerment of persons with disabilities and social participation of persons with disabilities in various countries. Therefore, it is concluded that the relevance as a whole is considered high.

#### 1) Conformity to the South African Policy

The South African government clearly states that the NDP aims to eliminate poverty and reduce inequality by 2030. The NDP acknowledges that many persons with disabilities are not able to develop to their full potential due to a range of barriers such as physical, information, communication and attitudinal barriers, and states that "Disability must be integrated into all facets of planning".

#### 2) Relevance to Japan's ODA policy towards South Africa

Country Assistance Policy for South Africa (2018) on Japan's ODA addresses an importance of promotion of social activities through its support for persons with disabilities as one of priority areas "Support to the socially vulnerable to participate in the economy and the society". To address this area, the programme is implemented to support correction of economic and social disparities in the country through the development of human resources in the provinces and districts community level for community development which support persons with disabilities as well as improving the social security system. The Project aligns with this programme.

#### 3) Consistency with the selection of C/P

Since the previous JICA advisor project (2012-2015), the Directorate of Services to Persons with Disabilities in the national DSD has been selected as a counterpart. The Directorate has the dual role regarding the provision of social development services to persons with disabilities. One role is to develop, implement, monitor, evaluate and report on disability specific interventions. The other is

to advise and guide all Department programmes on the mainstreaming of disability in all their social development services interventions. Through both roles, the Directorate contributes to the development of a social protection floor that is inclusive of the needs and rights of persons with disabilities, including what is needed to enable people to develop their capabilities. The purpose and activities of the Project align with the roles of the Directorate. Implementation of the Project contributed to capacitating the Directorate officials in order to fulfill their responsibilities.

#### 4) Appropriateness of selection of sites

The Project selected two study sites with aim to generate approaches and resources through activities conducted in the study sites. The project study sites were selected districts where provincial and district DSD officials showed high commitment through developing feasible action plans and implementing the planned activities after the disability mainstreaming training conducted by the previous JICA advisor (Disability Mainstreaming Advisor). Recognising commitment of DSD officials and related organisations in candidate sites, Vhembe district of Limpopo province was selected as Site 1 and Thabo Mofutsanyane district of Free State province was selected as Site 2.

#### 5) Relevance of cooperation approach

In the area of supporting disability programme in DSD, the Project is not overlapping with other donor agencies in the field of the empowerment of persons with disabilities and disability mainstreaming.

One of the roles of the counterpart (Directorate of Services to Persons with Disabilities) is to provide direct disability specific social development services to persons with disabilities, their family members and their representative organisations. The aims of the services are to provide residential, social and life skills community centres and respite care services to persons with disabilities, and to build the capacity of and empower persons with disabilities, their families, care-givers and social service practitioners. Another role is to advise and guide all DSD programmes on the mainstreaming of disability. However, large proportion of the resources and workloads of DSD at provincial and district level are spared for the supervision and monitoring of service providers which manage facilities such as residential institutions, social and life skills centres, etc. Therefore, it was not easy realistically for local officials of DSD to address empowerment of persons with disabilities and disability mainstreaming at community level as their realistic mandate. To tackle this situation, promoting empowerment of persons with disabilities and disability mainstreaming is a required action for the national DSD to address the gap between national policies and provincial/district programmes. It was appropriate that the Project shown the approaches which promote empowerment of persons with disabilities and disability mainstreaming, with practical activities at local level.

## 6) Relevance of project approach

### a) Scope of approaches developed by the Project (DEM approach)

According to the R/D, Scope of “approaches for implementing empowerment of persons with disabilities and disability mainstreaming in South Africa” is defined as a set of procedures consisting of

- Formulation of activities and processes for empowerment of persons with disabilities (e.g. peer counselling, leadership development etc.) and disability mainstreaming (e.g. universal design and information access etc.)
- Combination of these activities and processes based on needs and situations of persons with disabilities as well as societies
- Implementation with necessary stakeholders (e.g. persons with disabilities and officials etc.).

The Project developed six steps as the implementation steps of the DEM approach.

- Step 1: Create a platform at district level to obtain buy-in from key stakeholders
- Step 2: Establish a working group at local municipality level to guide and oversee the implementation process
- Step 3: Conduct training to empower the working group
- Step 4: Conduct a baseline survey, and develop an activity plan based on results of the survey
- Step 5: Implement planned activities by the working group
- Step 6: Monitor and evaluate in collaboration with three spheres of government and DPOs

In Step 4 and 5, the combination activities for empowerment of persons with disabilities and disability mainstreaming are implemented. The working group consisting of persons with disabilities, government officials and key stakeholders, and they play important roles for implementing the activities.

As mentioned above, since the actual scope of the approaches is same with the planned scope, relevance of the scope of approaches is high.

### b) Relevance of study site method

According to the original plan (from the R/D), "activities will be started in Site 1 in the 1st year and in Site 2 starting from the middle of the 2nd year. Activities vary from Site 1 to Site 2, depending on the needs of each site. Starting from the 4th year, DSD shall incrementally start implementing the approaches developed through the Project in other two sites (Site 3 and Site 4) outside the project framework. Technical guidance shall be provided to DSD by JICA Experts upon request". Then, as the original plan, the draft guidelines are finalised based on Site 1 and 2. In fourth year of the Project, the draft guidelines are used for activities in Site 3 and 4, and modified if need arises.

Actually, activities in Site 2 were started from the end of the 3rd year (2018). Thus the Project team had to support activities in Site 3 and 4 when started from the 4th year, follow up activities in Site 2,

monitor activities in Site 1, and develop the guidelines based on these activities of Site 1-4. One of reasons of the delay activities in Site 2 is that the Project team waited buy-in from the political heads of DSD. Since South Africa has greater decentralisation substantially, decision making of province is respected.

The study site method is effective in that it is possible to observe the activities implemented by the counterpart's ownership during the project term and to analyse whether these activities could be sustained after the project completion. It contributes to considering the sustainability of the project. On the other hand, it is not always the case where things go smoothly as planned in project sites. Thus it is recommended to keep sufficient time for the activities in study sites, especially for analytical purposes. It is needed that the study site method is elaborated more effective and efficient. The further explanation is shown in "3.4.2 Examination of study site method".

#### 7) Collaboration with relevant project

##### a) JICA partnership project “Capacity Building of Independent Living Centers through Creating Accessible Environment”

JICA has been implementing the JICA partnership project at two independent living centers in Gauteng province since April 2013. It aims to support independent living of persons with disabilities through development of personal assistants and peer counsellors. Human resources of this JICA partnership project had important roles for the Project, as trainers of training which were conducted by the Project. In addition, the Project team developed the guidelines in consultation with the above-mentioned human resources and key stakeholders of the JICA partnership project such as DPI-Japan and provincial disability coordinator of DSD Gauteng province.

##### b) JICA study “Does Learning the Social Model Improve Behavior towards Persons with Disabilities? A Randomized Experiment for Taxi Drivers in South Africa”

JICA implemented a study in 2018 to examine the impacts of the DET, targeting taxi drivers in Site 2. The Project supported to prepare a facilitator, venue and participants for conducting the DET. The main findings are that DET significantly encouraged taxi drivers to understand the social model, and that the combination of DET and practical support training had a significant impact on the time spent by drivers to support passengers with disabilities. These imply that learning the social model could lead to an improvement in the understanding of disability and, in part, actual behavior towards persons with disabilities.

(Working paper: [https://www.jica.go.jp/jica-ri/ja/publication/workingpaper/wp\\_204.html](https://www.jica.go.jp/jica-ri/ja/publication/workingpaper/wp_204.html))

#### 3.1.2 Effectiveness: High

The Project shows high effectiveness by implementing the planned activities and achieving the outputs. The target indicator which was set to measure the achievement of the project purpose is already achieved.

The DEM approach was developed as results of the planned activities and achieving the outputs. Through development process of the approach, capacities of DSD in empowerment of persons with disabilities and disability mainstreaming were enhanced. For instance, DSD commenced the DEM approach by their ownership in new districts: 1) OR Tambo district, Eastern Cape province; 2) iLembe district, KZN province; and 3) Mopani district. National DSD included the DEM approach in their annual performance plan (APP) in FY 2019 and FY 2020 officially.

### 3.1.3 Efficiency: Fair

Some plans were revised because some inputs were decreased and some activities were delayed. As per suggestion of South African side, the local resources have been utilised as much as possible, however, additional development of human resources is required to roll out the DEM approach in all provinces. However, the expected outcomes have been produced in the planned project duration, by strong commitment of South African side. Taking account of these things comprehensively, the efficiency is judged fair.

In FY 2018, the initial plan included dispatch of a short-term expert to South Africa and training programme in Japan, but these plans were cancelled due to serious tight budget of JICA. The initial plan in FY 2019 included visiting and/or inviting neighbouring countries as activities of Output 4 in FY 2019, but these plans were cancelled because the Project had to focus on the activities in/for South Africa. The reason behind is that the planned activities of Output 1, 2, and 3 in Site 2 were delayed, and the Project had to concentrate on those activities. In March – May 2020, the Project was unable to implement some planned activities such as printing and circulation of the guidelines and activities out of Gauteng province, due to coronavirus disaster. Due to the above-mentioned reasons, actual total amount of Japanese input was decreased 27 % from the initial planned amount.

As mentioned above, some inputs were decreased and some plans were revised, however the expected outcomes have been produced. Moreover, additional outcomes have been produced by DSD's ownership. For instance, the existing indicator of the Project Purpose is “DSD applies DEM approaches in at least two new districts”, but the DEM approaches have been commenced in three districts. In addition, the DEM guidelines will be approved by the Cabinet and rolled out in all provinces, with commitment by the Deputy Minister.

Since the roll out in all provinces will be realised, needs of further development of human resources were recognised. This is the remained issue after the Project completion.

National DSD showed a concrete strategy on how to roll out the DEM approach from national to provinces. On the other hand, at provincial level, it is needed further discussion how to roll out and sustain the DEM approach in their own provinces.

Taking account of these things comprehensively, the sustainability is judged fair because it could be improved.

### 3.1.4 Impact: Relatively high

The Overall goal is expected to realise within three years after the Project completion. For instance, the national DSD plans to utilise the DEM approach for a pilot project of Respite Care programme at pilot sites in two new provinces in FY 2020. Considering the achievement as per indicators of Overall goal, the indicator 1.1 likely to be realised sufficiently, while the probability of achieving indicator 1.2 still need to examined. (For further information, “IV. For the Achievement of Overall Goals after the Project Completion” is refereed.)

#### 1) Spillover Effects

##### (a) Cabinet approval of the guidelines as policy implementation documents

The guidelines will be submitted to the Cabinet as policy implementation document for “Policy on Social Development Services to Persons with Disabilities”. The guidelines will contribute to realise this policy through guide for implementing social development services for empowerment of persons with disabilities and disability mainstreaming in district level.

##### (b) Promoting a collaborating networking among different stakeholders in relation to the disability

The Project promoted an active collaborative networking among different stakeholders such as different level of DSD (national, province, district), different units of DSD (children, HIV/AIDS), local governments, different departments and persons with disabilities in local level. Especially, before the Project started, collaboration between DSD and municipalities was not so active. Usually, they invited their meetings on disability one another, but practical collaborative activities were not so common. Through the Project activities, those two organisations’ collaboration is closely strengthened at local level.

##### (c) Increase of job obtainment opportunities for persons with disabilities

The DEM working group worked together with local ward councillors, municipalities and DSD province/district to increase the participation of persons with disabilities in public works programmes such as Expanded Public Works Programme (EPWP) and Community Works Programme (CWP). For instance, the working group provided information to the local councillors on persons with disabilities who have potential to participate in the public works programmes. After this, the local ward councillors connected the public works programmes with these persons with disabilities. These actions contributed to the economic empowerment of persons with disabilities.

##### (d) Change of the relationship between persons with disabilities in communities and government officials

The results of interviews to the members of the working groups including persons with disabilities and government officials, made it clear that their mindset and relationship were changed toward more cooperative ways.

According to interview with persons with disabilities, in typical meetings with persons with disabilities and government official, government officials used to provide information and advice on disability, and persons with disabilities listened to their advice. However, after the Project was commenced, government officials got to listen to the voices of persons with disabilities and asked for inputs of persons with disabilities. Government officials responded to interview that communication ways between government officials and persons with disabilities have changed and their relationship became much better. Before the commencement of the Project, persons with disabilities made request about their needs and government officials then answered about their requests. This means they communicated at different levels, not as equals. Now, they discuss together how to address disability issues without any conflicting levels or position. The DEM project is simple, easily understandable and practical in comparison with other disability programmes. The roles of government officials are not just about providing funding, but also about listening to the voices of persons with disabilities and taking action based on their needs. The officials got to think and work with persons with disabilities together in order to solve disability issues.

### 3.1.5 Sustainability: Relatively high

Sustainability examines whether produced effects continue after the Project completion. The sustainability in terms of policy is high, because the South African policy directions are favorable to reduce inequality through empowerment and mainstreaming of targeting group including persons with disabilities. From the institutional point of view, it is high at the national DSD level. In such a way as to integrate the DEM approach into Respite Care programme, the national DSD will sustain the DEM approach by integrating the approach into existing programmes. In addition, the Deputy Minister of DSD announced publicly that she will implement show case to provincial DSD and the Office of the Premier in all nine provinces and presents the guidelines so that provincial political heads should acknowledge and understand the guidelines. On the other hand, at provincial and district level, it is difficult to predict on the institutional sustainability because it depends on priority and decision of each province. For the financial sustainability, the national DSD confirmed to secure a budget for implementation of the DEM approach under the Respite Care programme. On the other hand, at provincial and district level, it is difficult to predict on the financial sustainability because it depends on priority and decision of each province. The technical sustainability is regarded as relatively high. Technical level of the human resources developed by the Project is sufficient enough to implement activities using the DEM approach. In addition, the guidelines will help them to recap how to implement the activities. However, number of the develop human resources are not sufficient to cover all provinces. It would be required to develop human resources in each province.

As the above-mentioned situations, the sustainability is high at the national DSD level, but at provincial and district level, it is difficult to predict on the sustainability because it depends on priority



and decision of each province. Taking account of these things comprehensively, the sustainability is judged relatively high.

#### 1) Policy sustainability

The NDP aims to eliminate poverty and reduce inequality by 2030. The NDP acknowledges that many persons with disabilities are not able to develop to their full potential due to a range of barriers such as physical, information, communication and attitudinal barriers, and states that “Disability must be integrated into all facets of planning”.

The White Paper on the Rights of Persons with Disabilities (WPRPD) says that disability mainstreaming approach is one of strategic approach to realising the rights of persons with disabilities. The WPRPD also shows importance of empowerment of persons with disabilities in Pillar 4 - Promoting and Supporting Empowerment of Persons with Disabilities in the strategic pillars. In addition, the guidelines will work as policy implementation document for “Policy on Social Development Services to Persons with Disabilities”. The sustainability in the aspect of policy is expected to be maintained at a high level.

#### 2) Technical sustainability

Technical level of the human resources developed by the Project in Site 1 and the national DSD are sufficient enough to implement activities using the DEM approach. Three developed trainers of training also have sufficient skills to implement training. For Site 2, some human resources have sufficient skills to implement the activities, but others need more support and experiences to implement the activities. It would be required to train new human resources in new province when the DEM approach is rolled out there.

#### 3) Financial sustainability

The national DSD secured budget for the DEM approach in such a way as to integrate the DEM approach into Respite Care programme which already secured the budget officially. On the other hand, at provincial and district level, it is not yet certain regarding future allocation of financial resources for the DEM approaches as same level as the Project did. In Site 1, financial sustainability is high because they already implemented activities using developed resources by the Project initiatively. In Site 2 and 4, financial sustainability is slight high because they started discussion to plan to allocate budgets for the DEM approach. In Site 3 and new provinces, it is not yet certain on future allocation of financial resources for the DEM approach. The following items would essentially need to be budgeted for in each activity using the DEM approach: venue, catering, transport and training fee (honorarium). The following budget items are further required for activities at each step in the DEM implementation steps. The activities require simple and reasonable budget items. It is important for officials to have strong commitment to gain authorisation of the Head of Department, for securing the budgets.



#	STEP	TYPE OF ACTIVITY	EXAMPLES OF BUDGET ITEMS
1	Create a platform 	Meeting	<ul style="list-style-type: none"> <li>Venue and catering (if necessary)</li> <li>Transport for participants with disabilities</li> </ul>
2	Establish a working group 	Meeting	<ul style="list-style-type: none"> <li>Venue and catering (if necessary)</li> <li>Transport for participants with disabilities</li> </ul>
3	Capacity building for working group 	Training	<ul style="list-style-type: none"> <li>Venue and catering (if necessary)</li> <li>Transport for participants with disabilities</li> <li>Transport/flights for trainers with disabilities and their personal assistants (PA)</li> <li>Accommodation for trainers with disabilities and their PAs</li> <li>Training fee (honorarium)</li> <li>Equipment/materials (refer to Tool 5 on page 82 and Tool 15 on page 186)</li> </ul>
4	Baseline survey Develop an activity plan 	Questionnaire survey Workshop	<ul style="list-style-type: none"> <li>Venue and catering (if necessary)</li> <li>Transport for participants with disabilities</li> <li>Equipment/materials (refer to Tool 9 on page 112)</li> </ul>
5	Implement planned activities 	Community activity, meeting and others	<ul style="list-style-type: none"> <li>Venue and catering (if necessary)</li> <li>Transport for participants with disabilities</li> </ul>
		Training	<ul style="list-style-type: none"> <li>Venue and catering (if necessary)</li> <li>Transport for participants with disabilities</li> <li>Transport/flights for trainers with disabilities and their PAs</li> <li>Accommodation for trainers with disabilities and their PAs</li> <li>Training fee (honorarium)</li> <li>Equipment/materials (projector, laptop, hands out, training materials, etc.)</li> </ul>
6	Monitoring and evaluation 	Meeting	<ul style="list-style-type: none"> <li>Venue and catering (if necessary)</li> <li>Transport for participants with disabilities</li> </ul>

Diagram 3-1: Budget items required for activities

### 3.2 Key Factors Affecting Implementation and Outcomes

The planned activities of Output 1, 2, and 3 in Site 2 were delayed. According to the original plan, activities in Site 2 were going to start from the middle of 2017, but it was started from the end of 2018. One of the reasons behind is that it was taken a time to obtain buy-in from the political head of DSD to commence the activities. It took time to get buy-in from stakeholders at municipality level (such as local municipality, disability forum and community stakeholders) to commence the Project when the Project started in Site 1. As this experience of Site 1, to get buy-in from all stakeholders smoothly, an official launching by the Deputy Minister was planned in Site 2 before the Project start in Site 2. However, it was difficult to coordinate various stakeholders including high level officials to fix the date of launching. Finally, the launching was not realised and the activities in Site 2 was delayed.

In March – May 2020, the Project was unable to implement some planned activities such as printing and circulation of the guidelines and activities out of Gauteng province, due to coronavirus disaster. Due to it, the Project team could not circulate the completed guidelines to stakeholders before the Project completion. (However, the draft guidelines were shared with stakeholders at the DEM guidelines seminar in March 2020, and the Project team received feedback on the guidelines from the stakeholders.)

Even though some inputs were decreased and some activities were delayed from the initial plan, the expected outcomes have been produced and the project purpose has been achieved in the project term.

### **3.3 Evaluation on the results of the Project Risk Management**

In Ex-Ante Evaluation of the Project, lessons learnt of past projects on “Asia-Pacific Development Center on Disability Project Phase 2 (August 2007-July 2012)” was introduced. It was that persons with disabilities should involve all activities, process of project management at any level such as planning, implementation, monitoring, etc. It recommended that persons with disabilities should be members of the project working group and participate in the activities positively in collaboration with DPOs.

In the Project, one of three fundamental principles of the DEM approach concept is "Putting persons with disabilities first and centre". Persons with disabilities should participate as main agent in all process of activities from planning and monitoring. Persons with disabilities should be members of the working group, and the working group develops an activity plan based on results of the baseline survey which identify barriers and needs of persons with disabilities in the project sites. Majority of participants of training conducted by the Project are persons with disabilities, and trainers of these training are persons with disabilities. As above, persons with disabilities are indispensable for the Project and active as key member.

### **3.4 Lessons Learnt**

#### **3.4.1 Understanding of government system**

In the Project, it took time to gain buy-in from relevant persons including political heads of the department. It was not only national level but also provincial, district and local municipality levels. South Africa has greater decentralisation substantially, decision making of province and local governments are respected. Thus, it is important to understand the existing government systems including systems of decision making and budget allocation systems when the Project is implemented.

#### **3.4.2 Examination of study site method**

Structure of the study site method is that "activities will be started in Site 1 in the 1st year and in Site 2 starting from the middle of the 2nd year. Starting from the 4th year, DSD shall incrementally start implementing the approaches developed through the Project in other two sites (Site 3 and Site 4) outside the project framework. Technical guidance shall be provided to DSD by JICA Experts upon request". The draft guidelines are completed based on experiences in Site 1 and 2. In 4th year of the Project, the draft guidelines are trialed in Site 3 and 4, and modified if needs arise. It meant that the activities in Site 3 and 4 were implemented by ownership of DSD, in order to verify the DEM

approach and the guidelines”.

The study site method is effective in that it is possible to observe activities implemented by the counterpart during the project term and to analyse whether these activities could be sustained after the Project completion. The following points are shown as lesson learnt for improving the method.

#### 1) Term of activities in Site 3 and 4

As considering the real situations in the study sites, it is needed to examine the activity’s duration in each site. Especially for Site 3 and 4, it is recommended to implement activities for about two years so that analysis of the activity's results in Site 3 and 4 and development of the guidelines could be done more elaborate with sufficient time. For instance, the activities of Site 3 and 4 could be begun earlier (e.g. from beginning of 3rd year of the Project) or the Project term could be extended for the activities of Site 3 and 4 (e.g. 5 year project rather than 4 year one).

#### 2) Concrete stated documentation on agreement in the beginning the Project

It is important to discuss with counterpart sufficiently including alternative actions in case activities do not go as planned. Those discussion points should be documented in detail at the beginning stage of the project. The expected discussion points are: 1) detailed activity's schedule; 2) cost items which are covered by each organisation (particularly, the last year of the project); and 3) a way of making adjustments if the planned activities are delayed. These tasks help to address issues which occur during the project term. It is important to discuss with counterpart sufficiently including alternative actions in case activities do not go as planned. Those discussion points should be documented in detail at the beginning stage of the project. The expected discussion points are: 1) detailed activity's schedule; 2) cost items which are covered by each organisation (particularly, the last year of the project); and 3) a way of making adjustments if the planned activities are delayed. These tasks help to address issues which occur during the project term. Then, if some issues arise after the project is commenced, it is recommended to share the issue among the stakeholders (South African and Japanese sides both) as soon as possible. For instance, it could be used the opportunity of the first JCC (after about six months from the project commencement) to check progress of the planned activities, discuss issues and how to address with these issues.

## **4. For the Achievement of Overall Goals after the Project Completion**

### **4.1 Prospects to achieve Overall Goal**

**Overall goal: Empowerment of persons with disabilities and disability mainstreaming in South Africa are promoted through collaboration by DSD and the resources developed by the Project.**

As strong commitment and ownership of the national DSD, prospects to achieve Overall Goal have a high probability. The expected achievement as per each indicator is described Table 4-1.

Table 4-1: Expected achievements of Overall Goal as per indicator

Indicator	Achievement	Remark
<p>1. 'Approaches for empowerment of persons with disabilities and disability mainstreaming (DEM approaches)' are utilised in at least 5 provinces.</p>	<p>The DEM approaches will be utilised in <u>6 provinces</u> by March 2021.</p> <ul style="list-style-type: none"> <li>- The approaches were utilised in 4 provinces; Limpopo, Free State, Easterner Cape and KZN provinces.</li> <li>- In FY 2020, the national DSD plans to utilize the DEM approaches for Respite care programme in Mpumalanga and Northern Cape provinces.</li> </ul>	<p>Need consideration on affecting by the coronavirus lockdown, regarding 2020/21 APP.</p>
<p>2. At each province using the DEM approaches, 60% of DEM working group members with disabilities have confirmed that they participated in activities using the approaches actively.</p>	<ul style="list-style-type: none"> <li>- For Site 1 and 4, prospects to achieve Indicator have a high probability because the working group members with disabilities are participating in the activities actively.</li> <li>- For Site 2, if existing technical team members are targeted, prospects to achieve Indicator have a high probability because the members with disabilities are participating in the activities actively.</li> <li>- In Site 3, the working group's activities are getting behind in. On the other hand, the members with disabilities are using their knowledges and skills acquired by the Project for activities of their own DPOs.</li> <li>- For new sites identified after the Project completion, the working group members should be set clearly. Provincial DSD will coordinate for establishment of the working group in consultation with the national DSD using the DEM guidelines.</li> </ul>	<p>In Site 2, stakeholders agreed to establish the working group. District DSD needs to coordinate for its establishment in consultation with provincial DSD.</p> <p>For Site 3, follow-up will be needed.</p>

In 6th JCC in March 2020, the indicators of Overall Goal were revised to define the target group in order to collect necessary information for measuring the indicators. For instance, the indicators should be clarified and identified to collect necessary information such as who are '60 % of persons with disabilities' and how can we confirm 'be empowered'. Since the revisions make clear about activities for achievement of overall goal and points for follow-up of these activities, it enables feasible and sustainable monitoring by the counterpart. The revision is as follows;

Before:

[Indicators 1] 'Approaches for empowerment of persons with disabilities and disability mainstreaming' are utilised in at least 5 provinces.

[Indicator 2] 60% of persons with disabilities, where the DEM approaches were applied, are confirmed that they are empowered.

[Indicator 3] 60% of persons with disabilities in provinces, where the DEM approaches were applied, are confirmed that their social participation is realised.

After:

[Indicator 1] 'Approaches for the empowerment of persons with disabilities and disability mainstreaming (DEM approach)' are utilised in at least 5 provinces.

[Indicator 2] At each province using the DEM approaches, 60% of DEM working group members with disabilities have confirmed that they participated in activities using the approaches actively.

In the 6th JCC in March 2020, it was agreed that achievement of the indicators will be verified by activity records (e.g. attendance registers and monitoring reports) and interviews (to working group members and stakeholders).

#### **4.2 Plan of Operation and Implementation Structure of the South African side to achieve Overall Goal**

As per the announcement by the Deputy Minister of DSD, the DEM guidelines will be submitted and approved in the Cabinet. The implications of having the guidelines approved by Cabinet means that DSD will be expected to periodically submit progress reports to Cabinet, which provides a broader insight by all key stakeholders to monitor on whether the guidelines are implemented or not. This provides an idea on how the DEM approach can be rolled out and sustained.

The national DSD will circulate the guidelines which show approaches and resources developed by the Project to all provinces. The national DSD will support the rolling out of the DEM approach using the guidelines in remaining provinces. The Deputy Minister will participate in the showcase to be undertaken around the country to facilitate the successful implementation of the guidelines after the approval of the guidelines.

The new partnership project between JICA and DSD will focus on children with disabilities and their families, using the DEM approaches and resources. DSD intend to partner with JICA to pilot the guidelines on the Respite Care programme. JICA plans to dispatch an Advisor for this partnership in FY 2020. DSD identified two provinces to pilot the guidelines viz: Northern Cape and Mpumalanga provinces. The series of these plans contribute to sustaining the Project outcome and achieving Overall Goal.

In summary, for achievement of Overall Goal, the national DSD has a plan on how DEM approach can be successfully sustained: 1) Rolling out the implementation of the guidelines in other provinces following its approval by Cabinet; and 2) Integrating and utilising the DEM approach in other disability project.

#### **4.3 Recommendations for the South African side**

The following tasks are recommended to be undertaken by the South African side after completion of the Project.

##### **4.3.1 Obtainment of Cabinet approval and circulation of the guidelines to stakeholders**

The Project team has completed the final draft of guidelines which were revised based on feedback from the Deputy Minister and key stakeholders, for submitting to Cabinet. DSD will finalise the guidelines by Cabinet approval and circulate it to key stakeholders in all provinces. It is recommended to print the guidelines and circulate it to stakeholders as well as share of the electronic copy of the guidelines.

DSD will revise the guidelines if the political heads of the department and/or Cabinet request for the revision. If the guidelines will be modified and revised after the Project completion, DSD shall ask feedback from JICA South Africa office to revise it.

##### **4.3.2 Development of human resources**

One of main activities in the DEM approach is to conduct training for persons with disabilities, the working group and key stakeholders so that they capacitate to act for promoting empowerment of persons with disabilities and disability mainstreaming. In the Project, three trainers were developed sufficiently for training (Peer Counsellor Training, Disability Awareness Facilitator Training and Access Auditor Training). All trainers are persons with disabilities who live in Gauteng province. JICA and national DSD covered the training costs (transport/accommodation for trainers and their personal assistants and honorarium for trainers) during the Project term. After the Project completion, provincial DSD should conduct training by their ownership. But it is difficult for some provincial DSD to invite trainers from Gauteng province to their own provinces due to the lack of the budgets.

DSD is planning to discuss with stakeholders to address this challenge. For example, the meeting will be held with stakeholders of peer counselling to collect relevant information and discuss how to promote peer counselling. Outcomes of the meeting will be useful for the pilot project of Respite care programme.

#### 4.3.3 Discussion how to implement the DEM approach in the Respite Care programme

According to FY 2020 APP and Operational Plan of the national DSD for Respite Care programme, in the first quarter, selection of the two pilot sites is facilitated and implementation team is established. These activities are activities of Step 1 (create a platform) and Step 2 (establish a working group) of the DEM implementation steps. In the second quarter, the activities of following Steps will be implemented such as training for the team, baseline survey, development of an activity plan, implementation of the planned activities, etc. It is recommended to discuss concretely how to implement specific activities as the DEM approach.

#### **4.4 Monitoring Plan from the end of the Project to Ex-post Evaluation**

During the project term, the progress of the project activities was reported by provincial disability coordinators at provincial disability coordinator's meetings quarterly. This way will continue after the Project completion. The guidelines describe importance of monitoring and recommend that progress of the activities is reported at the provincial disability coordinator's meeting. The monitoring template is attached in the guidelines. JICA advisor and/or JICA official could attend to the provincial disability coordinator's meetings as observers so that they collect useful information about the progress of Overall Goal's achievement of the Project. The suggested dates of the provincial disability coordinator's meetings for FY 2020 are as follows:

- 11-15 May 2020 in KwaZulu Natal province
- 17-21 August 2020 in Free State province
- 12-16 October 2020 in Western Cape province
- 15-19 February 2021 in Mpumalanga province

END

**ANNEX:** DEM guidelines (including various materials and project activity's pictures)









# GUIDELINES

## ON SERVICES TO PERSONS WITH DISABILITIES FOR THE EMPOWERMENT OF PERSONS WITH DISABILITIES AND DISABILITY MAINSTREAMING AT DISTRICT LEVEL



A practical guide to implementation of the  
Empowerment of Persons with Disabilities and  
Disability Mainstreaming (DEM) approach

APRIL 2020

Building a Caring Society. Together.

[www.dsd.gov.za](http://www.dsd.gov.za)



social development

Department:  
Social Development  
REPUBLIC OF SOUTH AFRICA



## **COVER PHOTO CREDITS**

### **Top row left to right:**

Persons with disabilities facilitate a disability awareness activity in the community (Free State)

Persons with disabilities and government officials check accessibility at a special school (KZN)

Persons with disabilities and government officials assess accessibility at a government office (Limpopo)

### **Bottom row left to right:**

Persons with disabilities participate in Peer Counsellor Training (Eastern Cape)

Person with disability facilitates a disability awareness activity for government officials (Limpopo)

Working group consisting of persons with disabilities and social workers discuss and develop activity plans (Eastern Cape)

# GUIDELINES

## ON SERVICES TO PERSONS WITH DISABILITIES FOR THE EMPOWERMENT OF PERSONS WITH DISABILITIES AND DISABILITY MAINSTREAMING AT DISTRICT LEVEL

A practical guide to implementation of the  
Empowerment of Persons with Disabilities and  
Disability Mainstreaming (DEM) approach

APRIL 2020

Developed by the Department of Social Development (DSD)  
and Japan International Cooperation Agency (JICA)



Developed by the Department of Social Development (DSD) and the Japan International Cooperation Agency (JICA)

© The Department of Social Development and the Japan International Cooperation Agency 2020

# CONTENTS

List of tools	vi
Abbreviations and acronyms	vii
Foreword by the Minister	viii
Overview by the Deputy Minister	ix
Overview by the Chief Representative of JICA South Africa Office	x
Acknowledgements	xi
Executive summary	xii
<b>PART 1 INTRODUCTION</b>	<b>1</b>
Background	2
Purpose and scope of the guidelines	2
Methodology for developing the guidelines	3
How to use the guidelines	3
<b>PART 2 POLICY FRAMEWORK AND CONCEPT</b>	<b>5</b>
Policy framework	6
Concept of empowerment of persons with disabilities and disability mainstreaming approach (DEM approach)	6
<b>PART 3 IMPLEMENTATION</b>	<b>9</b>
<b>Overview of implementation</b>	<b>10</b>
Implementation steps	10
Implementation structures	12



<b>STEP 1: Create a platform at district level to obtain buy-in from key stakeholders</b>	<b>17</b>
Creating a platform	17
Identifying an implementation site	17
<b>STEP 2: Establish a working group at local municipality level to guide and oversee the implementation process</b>	<b>18</b>
Functions of a working group	18
Expected members of a working group	18
<b>STEP 3: Conduct training to empower the working group</b>	<b>20</b>
Training for working group members with disabilities	20
Training for working group members	24
<b>STEP 4: Conduct a baseline survey, and develop an activity plan based on results of the survey</b>	<b>26</b>
Conduct a baseline survey	26
Develop an activity plan in the DEM introductory workshop	28
<b>STEP 5: Implement planned activities by the working group</b>	<b>31</b>
Site 1: Collins Chabane municipality, Vhembe district, Limpopo province	31
Site 2: Maluti-a-Phofung municipality, Thabo Mofutsanyana district, Free State province	32
Site 3: Nyandeni municipality, OR Tambo district, Eastern Cape province	33
Site 4: Mandeni municipality, iLembe district, KwaZulu-Natal province	33
Example of practical activities: Access audit	34
<b>STEP 6: Monitor and evaluate in collaboration with three spheres of government and DPOs</b>	<b>36</b>
Monitoring template	36
Roles and responsibilities in monitoring and evaluation	37

<b>PART 4</b>	<b>RESOURCES REQUIRED</b>	<b>39</b>
	Human resources	40
	Materials for training and activities	41
	Financial resources	41
<b>PART 5</b>	<b>GOOD PRACTICE CASE STUDIES</b>	<b>45</b>
	Disability mainstreaming in different directorates in DSD	46
	Disability mainstreaming in different departments and sectors	49
	Collaboration with municipalities	51
<b>PART 6</b>	<b>CONCLUSION</b>	<b>53</b>
	Bibliography	55

## LIST OF TOOLS

---

<b>Tool 1:</b>	Example of Terms of Reference of Working Group for Implementing the DEM Approach	58
<b>Tool 2:</b>	Facilitation Guide on Peer Counsellor Training	60
<b>Tool 3:</b>	Presentation on Peer Counsellor Training	68
<b>Tool 4:</b>	Materials on Peer Counsellor Training	72
<b>Tool 5:</b>	Facilitation Guide on Disability Awareness Facilitator Training	82
<b>Tool 6:</b>	Presentation on Disability Awareness Activity	92
<b>Tool 7:</b>	Questionnaire Form for Baseline Survey	104
<b>Tool 8:</b>	Example of Report on Results of the Baseline Survey	110
<b>Tool 9:</b>	Facilitation Guide on DEM Introductory Workshop: to develop an activity plan	112
<b>Tool 10:</b>	Presentation on DEM Introductory Workshop	122
<b>Tool 11:</b>	Activity Plan and Monitoring Template	130
<b>Tool 12:</b>	Example of a Developed Activity Plan	132
<b>Tool 13:</b>	Facilitation Guide on Access Auditor Training	134
<b>Tool 14:</b>	Presentation on Access Auditor Training	154
<b>Tool 15-1:</b>	Materials on Access Auditor Training: Simplified Ramp Gradient Finder	186
<b>Tool 15-2:</b>	Materials on Access Auditor Training: Access Audit Checklist	187
<b>Tool 15-3:</b>	Materials on Access Auditor Training: Access Audit Report Template	193

# ABBREVIATIONS AND ACRONYMS

**ASSA** – Albinism Society of South Africa

**CEG** – Community-based Empowerment Group

**CWP** – Community Work Programme

**CYCC** – Child and Youth Care Centre

**DEM** – Empowerment of persons with disabilities and disability mainstreaming

**DPO** – Disabled People’s Organisation

**DPW** – Department of Public Works

**DSD** – Department of Social Development

**EPWP** – Expanded Public Works Programme

**HOD** – Head of Department

**JICA** – Japan International Cooperation Agency

**NDP** – National Development Plan

**NGO** – Non-governmental organisation

**NPO** – Non-profit organisation

**SANS** – South African National Standard

**SASSA** – South African Social Security Agency

**SHG** – Self-Help Group

**UN** – United Nations

**UNCRPD** – United Nations Convention on the Rights of Persons with Disabilities

**WPRPD** – White Paper on the Rights of Persons with Disabilities



## FOREWORD

By the Minister

The National Development Plan 2030 (2013) aims to eliminate poverty and reduce inequality by 2030, towards achieving a “country wherein all citizens have the capabilities to grasp the ever-broadening opportunities available”.

The NDP acknowledges that many persons with disabilities are not able to develop their full potential due to a range of barriers such as physical, information, communication and attitudinal barriers, and states that “Disability must be integrated into all facets of planning”.

The White Paper for Social Welfare (1997) also acknowledges that disability in a family increases the impact of poverty, and that poverty is one of the most important causes of hunger and malnutrition which contribute in turn to illness and disability. This means that disability and income reaffirms the existence of a strong relationship between disability and poverty.

Towards the achievement of the goals of the NDP, persons with disabilities should be empowered so that they gain self-reliance, skills and social participation, including full involvement in economic activities. Furthermore, any planning, legislation, policies and programmes in any areas and at all levels should be assessed from a disability perspective and involve persons with disabilities, towards disability mainstreaming.

The guidelines show how to accelerate empowerment of persons with disabilities and disability mainstreaming at district level, in order to deliver services to persons with disabilities efficiently, effectively and coherently. The utilisation of the guidelines is aligned with the District Development Model which aims to accelerate, align, and integrate service delivery under a single development plan per district or metro that is developed jointly by national, provincial and local governments.

We want to build a caring and self-reliant society for all. We believe that the guidelines will be utilised in all provinces, and contribute to improving the quality of life of persons with disabilities and their families.

A handwritten signature in black ink, appearing to read 'L. Zulu'.

**Ms LINDIWE ZULU, MP**

Minister of Social Development



## OVERVIEW

By the Deputy Minister

The overall purpose of the guidelines is to ensure the promotion of disability mainstreaming and empowerment of persons with disabilities, in line with the White Paper on the Rights of Persons with Disabilities (WPRPD), as well as the United Nations Convention on the Rights of Persons with Disabilities (UNCRPD).

The Department of Social Development (DSD) has implemented a four-year technical cooperation project in collaboration with the Japan International Cooperation Agency (JICA) to develop an approach on the empowerment of persons with disabilities and disability mainstreaming (the DEM approach). It aims to ensure the provision of social development services to persons with disabilities to improve the overall quality of their lives, in line with the vision of the National Development Plan (NDP) to see the country free from poverty and discrimination by 2030, and the UN's 2030 Agenda for Sustainable Development pledge of *Leaving no one behind*.

The DEM guidelines introduce an approach that shows the participation of persons with disabilities in the implementation of mainstreaming in the public services and community activities. This approach emphasises the empowerment of persons with disabilities as a first step towards their active participation, followed by creating a platform for persons with disabilities, governments, municipalities and other stakeholders to roll out disability mainstreaming.

Towards developing the DEM guidelines, DSD and JICA implemented a variety of activities in the study sites in four provinces: Limpopo, Free State, Eastern Cape and KwaZulu-Natal. These activities were accomplished through supportive partnerships and cooperation among provincial governments, municipalities, relevant departments, NGOs, Disabled People's Organisations (DPOs), national and international organisations.

Part of the activities of this project included establishing partnerships with the neighbouring countries of Eswatini, Lesotho, Mozambique and Zimbabwe, with the aim of strengthening the relationship and sharing best practice models of disability mainstreaming.

Persons with disabilities, including children with disabilities, still experience severe forms of discrimination, isolation and exclusion from society, especially in the areas of basic needs and services such as education, health, transport, employment, water, food, housing, etc. We must double our efforts to correct this. The DEM guidelines should be utilised by all three spheres of government, civil society, and other stakeholders to promote disability mainstreaming and empowerment of persons with disabilities, ensuring that persons with disabilities are fully included and integrated in all sectors of our society in the South Africa we want.

A handwritten signature in black ink, appearing to read 'Hendrietta Bogopane-Zulu'.

**Ms HENDRIETTA BOGOPANE-ZULU**

Deputy Minister of Social Development



## OVERVIEW

By the Chief Representative of JICA South Africa Office

I would like to take this opportunity to convey JICA's appreciation for the productive collaboration with the Department of Social Development (DSD) of the Republic of South Africa that we have achieved so far, towards the promotion of social participation of persons with disabilities in South Africa.

JICA has been closely working and walking with the DSD in implementing a variety of cooperation programmes on disability since 2002, such as training in Japan, provision of accessible vehicles, dispatch of disability advisers, and implementation of technical cooperation projects.

JICA, with its partners, takes the lead in forging bonds of trust across the world, aspiring to a free, peaceful and prosperous world where people can hope for a better future and explore their diverse potentials. JICA's vision is 'Leading the world with trust'.

Even though support for persons with disabilities is generally considered as a part of social welfare services, JICA views persons with disabilities not simply as recipients of welfare services but also as important actors in development. JICA's ultimate goal is to build a society that is comfortable to live in for all people, regardless of disabilities. JICA aims to realise the 'full participation and equality' of every person with disability in developing countries, with a twin-track approach. The first track is empowering persons with disabilities through leadership training and strengthening the capacity of disabled people's organisations; and the second track is mainstreaming through creating barrier-free environments to ensure the active participation of persons with disabilities in society.

The DEM guidelines have been developed to roll out the DEM approach across all provinces, towards promoting the empowerment of persons with disabilities and promoting disability mainstreaming. The DEM guidelines are not unchangeable. While making use of the basic concept of the DEM guidelines, you can adjust them according to each situation. I believe the DEM approach can evolve in this way. In the various provinces and diverse instances of disability, let's try to use the DEM approach to DEMonstrate its effectiveness!

This initiative could contribute not only to South Africa's development but also that of our neighbouring countries in southern Africa. Why wouldn't one want to spread good initiatives from South Africa to other countries? Your country can and should play such a role.

Again, I express my gratitude for the joint efforts to develop the DEM guidelines based on the four-year technical cooperation project between DSD and JICA, as well as the success of the project. I believe in continuous cooperation with the South African government to achieve the 'full participation and equality' of persons with disabilities.

**Mr TOMOHIRO SEKI**

Chief Representative of JICA South Africa Office

# ACKNOWLEDGEMENTS

The Department of Social Development (DSD), guided by its mission to transform our society by building conscious and capable citizens through the provision of comprehensive, integrated and sustainable social development services, has collaborated broadly with key stakeholders and the Japan International Cooperation Agency (JICA) in the development of a good practice model on empowerment of persons with disabilities and disability mainstreaming (DEM).

In doing this, the department acknowledges the support and collaboration of provincial departments, district and local municipalities, state departments, the disability sector and other stakeholders that committed themselves to the objective of improving the quality of life for our persons with disabilities.

Through the DEM project, the various stakeholders mentioned above have worked jointly to establish the good practice model that has provided learning opportunities for all.

Development of the DEM guidelines document was largely based on the work carried out in the four study sites, namely:

- 1) Collins Chabane local municipality, Vhembe district, Limpopo province;
- 2) Maluti-a-Phofung local municipality, Thabo Mofutsanyana district, Free State province;
- 3) Nyandeni local municipality, OR Tambo district, Eastern Cape province; and
- 4) Mandeni local municipality, iLembe district, KwaZulu-Natal province.

We appreciate the dedication and commitment of the senior management, officials and coordinators of the various departments, representatives from the disability sector and local authorities, not forgetting persons with disabilities and their families who worked together to develop the programmes and services for empowering persons with disabilities and disability mainstreaming. Their work has been positively integrated in the development of the guidelines.

We hope this document will serve its purpose: to guide any community, institution, organisation, and department in developing and improving services for persons with disabilities.



# EXECUTIVE SUMMARY

The empowerment of persons with disabilities and disability mainstreaming (DEM) approach is a way to empower persons with disabilities and create a platform for persons with disabilities, governments, municipalities and other key stakeholders for the realisation of the participation of persons with disabilities in mainstreaming at district and local level.

The aim of the DEM guidelines is to explain how to implement the DEM approach, in six parts. Part 1 introduces the background of the guidelines which have been developed through a four-year international technical cooperation project between DSD and JICA, called 'Promotion of Empowerment of Persons with Disabilities and Disability Mainstreaming', from May 2016 to May 2020. The guidelines were developed based on the experiences and lessons learned in activities in the four project study sites in four different provinces: Limpopo, Free State, Eastern Cape and KwaZulu-Natal.

Part 2 defines and clarifies the DEM approach by its central concept. The DEM approach shows how persons with disabilities can and do participate in the implementation of disability mainstreaming at district and local level. In addition, the DEM approach emphasises that persons with disabilities and their families should first be empowered in order to realise their active participation in disability mainstreaming, and create a platform for persons with disabilities, governments, municipalities and other key stakeholders.

The concept behind the DEM approach rests on three fundamental principles:

- 1) putting persons with disabilities and their families first and centre;
- 2) developing government capacity and systems; and
- 3) creating inclusive communities through practical activities.

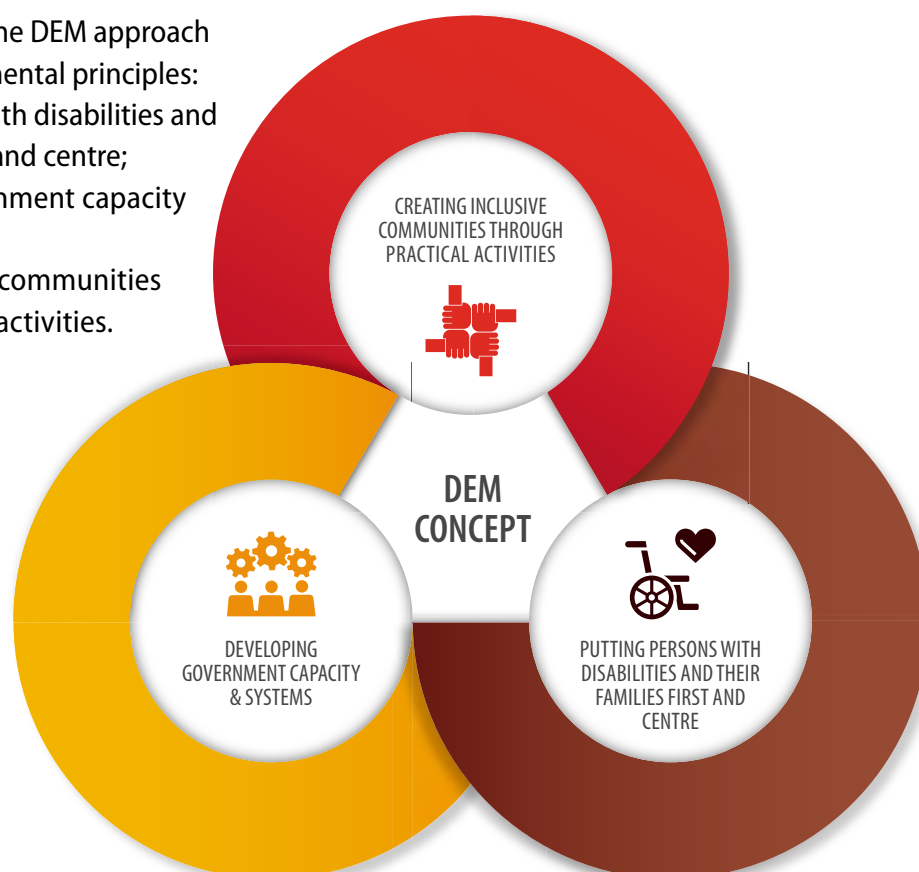

Part 3 explains how to implement the DEM approach by showing the implementation steps of the DEM approach. The implementation steps can be described in the following six steps:



In Part 3, a range of concrete practical activities is shown as references for the DEM approach to implement including: establishing a working group; capacity building training; conducting a baseline survey, developing an activity plan at DEM introductory workshop, etc. As useful references to implement each practical activity, training facilitation guides, workshop presentation slides, and other materials are included in this book as Tools 1–15.

An important reminder is that at every step of this process, persons with disabilities and their families are to be placed first and centre, and should be active members of all discussions, decisions and activities.

In Part 4, the specific resources required are listed, including human resources and financial resources. Adequate and appropriate resource allocation is a critical factor for the success of continuous implementation of the planned activities.

Part 5 introduces the good practice that is used in the DEM approach, such as disability mainstreaming in various directorates in DSD, different departments and sectors, and collaboration with local municipalities.

Part 6 summarises the five key elements of the DEM approach, as follows:

- Persons with disabilities and their families should be first and centre in all processes and activities
- It is a principle to capacitate and empower persons with disabilities first to enable their active participation in activities
- Another principle is to establish a working group consisting of persons with disabilities, governments, municipalities and other key stakeholders; this enables them to work together as equals in a team
- The working group develops an activity plan to address barriers faced by persons with disabilities in the implementation site
- Activities are implemented in communities at local municipality level in collaboration with national, provincial and district governments



Persons with disabilities and a government official facilitate a disability awareness activity in the community (Free State)



# PART 1



DSD official listens to caregivers describe the challenges and needs of children with disabilities (Free State)

## INTRODUCTION

## BACKGROUND

---

The South African government continues to strive towards the elimination of poverty and inequality. To this end, it has put various policies and legislation in place to ensure the equitable distribution of economic and social development. In 2007, the United Nations Convention on the Rights of Persons with Disabilities (UNCRPD) was ratified. In South Africa, the White Paper on the Rights of Persons with Disabilities (WPRPD) was formulated in 2015 for the practical realisation of the rights of persons with disabilities. However, the country continues to face persistent and even widening inequality. Despite the existence of policies and measures such as the disability grant, persons with disabilities continue to be excluded from education, training and employment, and remain among the poorest of the poor. Lack of implementation of policy is a common problem across South Africa, especially in rural areas.

The Department of Social Development (DSD) is at the forefront of providing social development services to persons with disabilities, including creating the necessary policy, mainstreaming disability in all the department's programmes, and implementing empowerment and awareness-raising projects.

In an international cooperation initiative, DSD requested technical support from the Government of Japan to develop services to persons with disabilities, with the aims of both empowerment and mainstreaming. Hence in 2012, the Japan International Cooperation Agency (JICA) dispatched an advisor on disability mainstreaming who, in collaboration with DSD, conducted disability mainstreaming training for both national and provincial department officials. A total of 617 participants acquired knowledge on disability mainstreaming in the training sessions between 2013 and 2015.

As an outcome of the above-mentioned training, DSD requested technical cooperation with JICA for further strengthening the capacity of DSD officials to implement the empowerment of persons with disabilities and disability mainstreaming at local level. As a result, a four-year project for the 'Promotion of Empowerment of Persons with Disabilities and Disability Mainstreaming' was implemented from May 2016 to May 2020 as a technical cooperation project between DSD and JICA. Through the implementation of the project, DSD and JICA developed the empowerment of persons with disabilities and disability mainstreaming (DEM) approach which realises the empowerment of persons with disabilities and disability mainstreaming at district and local level.

## PURPOSE AND SCOPE OF THE GUIDELINES

---

The DEM guidelines have been developed primarily for DSD officials and all public service employees, especially at district and local level to use the DEM approach in their programmes and services. It provides guidance and practical steps on how to promote the empowerment of persons with disabilities and disability mainstreaming at district and local level through offering concrete activities and good practice.



## METHODOLOGY FOR DEVELOPING THE GUIDELINES

The guidelines were developed based on the experiences and lessons learned from activities in the four study sites include:

- SITE 1** Collins Chabane municipality, Vhembe district, Limpopo province
- SITE 2** Maluti-a-Phofung municipality, Thabo Mofutsanyana district, Free State province
- SITE 3** Nyandeni municipality, OR Tambo district, Eastern Cape province
- SITE 4** Mandeni municipality, iLembe district, KwaZulu-Natal province

The project was started in site 1 from May 2016, while site 2 began in 2018 based on the collective experience of the activities at site 1. A draft of the guidelines was developed from the lessons learned in the activities at sites 1 and 2, in March 2019. From April 2019, the project was rolled out to sites 3 and 4. The draft guidelines were then utilised for activity implementation at these sites to validate usability and effectiveness. Finally, the guidelines were completed in April 2020 based on the lessons learned in the project activities from 2016 to 2020 at all four study sites.

## HOW TO USE THE GUIDELINES

Everyone who uses the guidelines is encouraged to follow the implementation steps of the DEM approach as well as the DEM concept: this concept is set out in Part 2. The implementation steps are shown in Part 3 in six steps which describe a range of practical activities. As references to implement each practical activity in each step, materials such as training facilitation guides and workshop presentation slides are included as Tools 1–15. In Part 4, the specific resources required are listed, and Part 5 introduces good practice to be referred to especially in promoting empowerment of persons with disabilities and disability mainstreaming. Part 6 summarises the five key elements of the DEM approach.



A person with visual impairment explains what kind of support he requires to taxi drivers (Free State)



Persons with disabilities prepare for a disability awareness activity (Free State)



A government official conducts disability mainstreaming training (Limpopo)





Persons with disabilities and government officials assess accessibility in the parking lot of a government office (Limpopo)



## PART 2

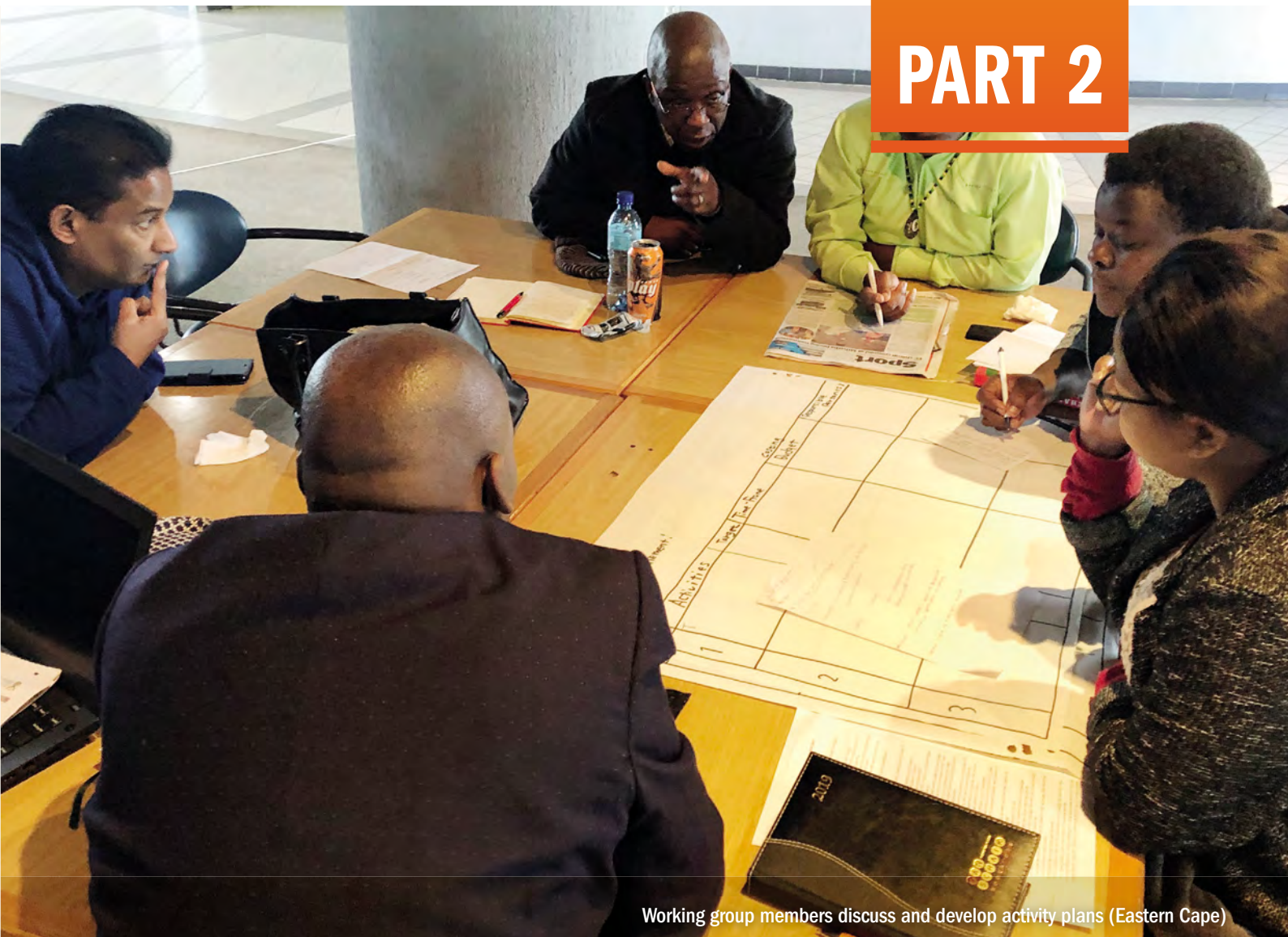

Working group members discuss and develop activity plans (Eastern Cape)

# POLICY FRAMEWORK AND CONCEPT



## **POLICY FRAMEWORK**

---

The DEM guidelines were initially developed in line with significant national policies such as the National Development Plan 2030 (2013), the WPRPD (2015), the Disability Mainstreaming Implementation Toolkit (2012), and later on the Policy on Social Development Services to Persons with Disabilities (drafted in 2019) and the District Development Model (2019).

In addition, the guidelines referred to international and regional policies such as the UNCRPD, Sustainable Development Goals (SDGs), Protocol to the African Charter on Human and Peoples' Rights on the Rights of Persons with Disabilities in Africa, and the Continental Plan of Action for the African Decade of Persons with Disabilities

### **White Paper on the Rights of Persons with Disabilities (WPRPD)**

Cabinet approved the WPRPD in 2015 to accelerate transformation and redress so as to achieve full inclusion and equality for person with disabilities. The WPRPD integrates the obligations of the UNCRPD and the Continental Plan of Action for the African Decade of Persons with Disabilities, with South Africa's legislation, policy frameworks and the National Development Plan 2030.

### **Disability Mainstreaming Implementation Toolkit**

The Disability Mainstreaming Implementation Toolkit was developed by the DSD in 2012. It aims to offer step-by-step guidelines on implementing disability mainstreaming to ensure that disability is integrated into all government programmes and budgets with the purpose of increasing the participation of persons with disabilities within government and local communities.

## **CONCEPT OF EMPOWERMENT OF PERSONS WITH DISABILITIES AND DISABILITY MAINSTREAMING APPROACH (DEM APPROACH)**

---

Through the DSD/JICA technical cooperation project, an approach has been developed for implementing the empowerment of persons with disabilities and disability mainstreaming at district and local level in South Africa; it is called the empowerment of persons with disabilities and disability mainstreaming (DEM) approach. The DEM approach is a way to empower persons with disabilities and create a platform for persons with disabilities, municipalities and other key stakeholders for realisation of the participation of persons with disabilities in the mainstreaming at district and local level.

The DEM approach is based on the social model of disability, which is a key perspective to promote the empowerment of persons with disabilities and disability mainstreaming. The social model sees disability as a social construct, with disability arising not from individuals but from a social environment where diversity is not fully respected. The DEM approach therefore looks at ways of removing barriers that restrict the life choices of persons with disabilities.

Through the DEM approach, DSD collaborates with persons with disabilities, key departments, municipalities and community stakeholders to implement practical activities for removing the various social barriers that persons with disabilities face, towards creating inclusive communities.

The concept behind the DEM approach rests on three fundamental principles that make up this unique approach to empowering persons with disabilities and mainstreaming disability.

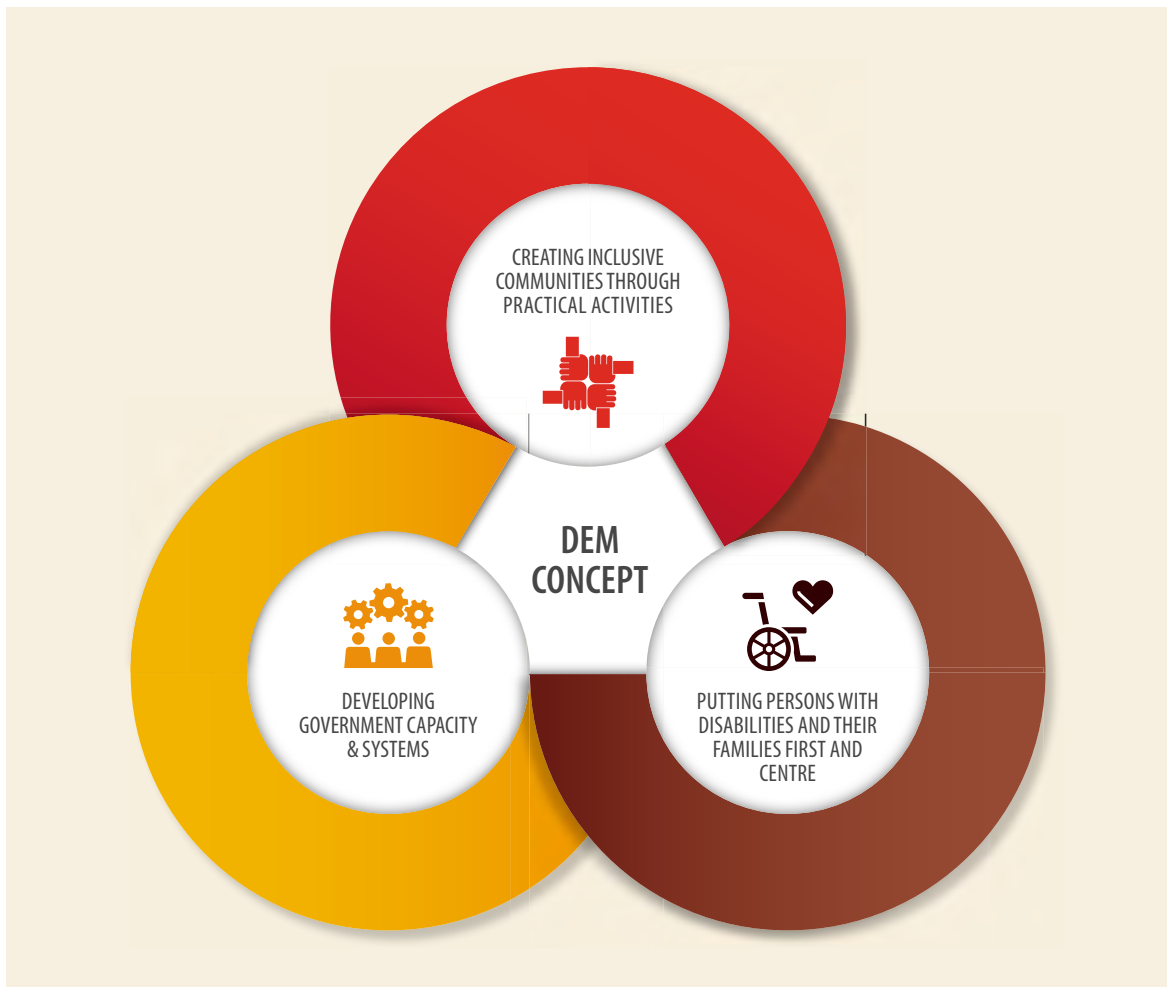

The concept of the DEM approach has three fundamental principles

### **PRINCIPLE 1: Putting persons with disabilities and their families first and centre**

Among the major challenges that persons with disabilities face is a lack of self-representation, skills and social participation. It follows then that in any programme that aims to empower persons with disabilities and promote disability mainstreaming, persons with disabilities and their families must be the main actors. The DEM approach puts persons with disabilities and their families first and centre, in line with the principle, 'Nothing about us, without us'. Building on this foundation, activities for the empowerment of persons with disabilities and their families should be implemented first.



Putting persons with disabilities and their families first and centre is the first principle of the DEM approach

## PRINCIPLE 2: Developing government capacity and systems

The United Nations (UN) defines mainstreaming as the process of assessing the implications for persons with disabilities of any planned action, including legislation, policies or programmes, in any area and at all levels. Thus it is essential to capacitate government officials to mainstream disability in any and all government policies and programmes, and to create sustainable systems for disability mainstreaming. The DEM approach aims to develop the capacity, mindset, and skills of government officials, and to establish sustainable structures of government to underpin activities on empowerment of persons with disabilities and disability mainstreaming.

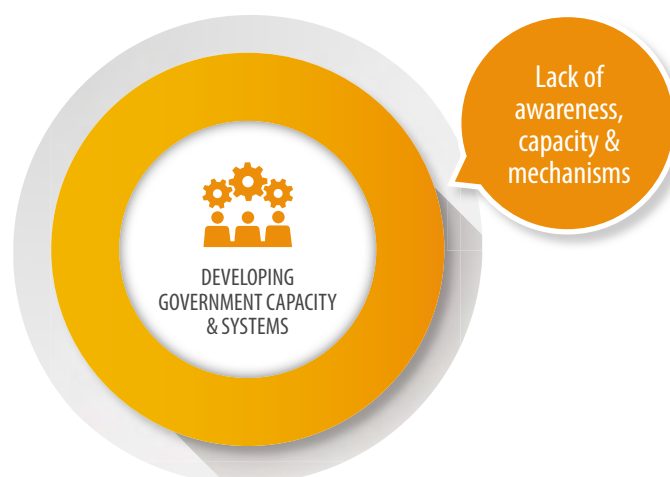

Developing government capacity and systems is the second principle of the DEM approach

## PRINCIPLE 3: Creating inclusive communities through practical activities

The DEM approach places value on community-based activities which pay attention to the lives of persons with disabilities, especially concerning their participation in all aspects of community life. This is because a sectoral, top-down approach would not be sufficient or appropriate for the full participation of persons with disabilities.

In the DEM approach, the barriers faced by persons with disabilities need to be brought out, and these barriers have to be addressed by persons with disabilities and relevant stakeholders in their communities. To this end, barriers are identified through baseline surveys which are conducted in their communities. Then training for persons with disabilities and other stakeholders is conducted to capacitate them to address the identified barriers. The training is not just theoretical but always features a hands-on, practical component where participants learn through applied activities.

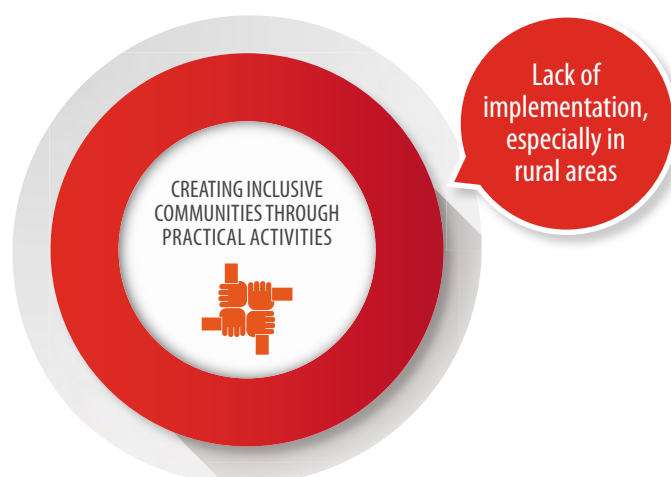

Creating inclusive communities through practical activities is the third principle of the DEM approach

The central idea behind the DEM approach is to create a platform for persons with disabilities, governments, municipalities and other key stakeholders, working together to implement various practical activities towards creating an inclusive community. As a result of a series of collaborative implementations, these activities will be institutionalised or integrated in government systems for sustainability.

The DEM approach is versatile enough to be adapted to different environments and circumstances, at any level, area and sector.

## PART 3



Persons with disabilities facilitate a disability awareness activity at a high school (Limpopo)

# IMPLEMENTATION



## OVERVIEW OF IMPLEMENTATION

In order to realise disability mainstreaming, every programme and sector should include a disability perspective, and ensure that persons with disabilities participate in the process of planning and implementation. This part of the guidelines offers concrete practical activities as a reference for empowerment of persons with disabilities and disability mainstreaming (DEM).

### IMPLEMENTATION STEPS

The implementation steps of the DEM approach can be described in six steps. In these steps, practical activities are implemented to achieve the objective of each step. Part 3 shows how to implement the practical activities in each step, with concrete activity examples. The six steps are as follows:

STEPS	PRACTICAL ACTIVITY EXAMPLES
 <p><b>STEP 1</b> (PG 17) Create a platform at district level to obtain buy-in from key stakeholders</p>	<ul style="list-style-type: none"> <li>• Create a platform</li> <li>• Identify a implementation site</li> </ul>
 <p><b>STEP 2</b> (PG 18) Establish a working group at local municipality level to guide and oversee the implementation process</p>	<ul style="list-style-type: none"> <li>• Establish a working group</li> <li>• Confirm terms of references of the working group</li> </ul>
 <p><b>STEP 3</b> (PG 20) Conduct training to empower the working group</p>	<ul style="list-style-type: none"> <li>• Peer counselling</li> <li>• Disability Awareness Facilitator Training</li> <li>• Disability awareness activity</li> </ul>
 <p><b>STEP 4</b> (PG 26) Conduct a baseline survey and develop an activity plan based on results of the survey</p>	<ul style="list-style-type: none"> <li>• Questionnaire survey</li> <li>• Analysis and compilation of results of the survey</li> <li>• DEM introductory workshop to develop an activity plan</li> </ul>
 <p><b>STEP 5</b> (PG 31) Implement planned activities by the working group</p>	<ul style="list-style-type: none"> <li>• Peer counselling</li> <li>• Disability awareness activity</li> <li>• Access audit, etc.</li> </ul>
 <p><b>STEP 6</b> (PG 36) Monitor and evaluate in collaboration with three spheres of government and DPOs</p>	<ul style="list-style-type: none"> <li>• Progress report using a monitoring template</li> </ul>

Six steps of the DEM implementation steps and practical activities

## Reasons behind the six steps of the DEM implementation steps

The implementation steps were developed based on the experience of a four-year DSD/JICA technical cooperation project.

It remains essential that all municipalities should implement the DEM approach for promoting disability mainstreaming. However, for focusing on intervention of the implementation, an implementation site should be identified by showing appropriate reasons and compelling needs for the establishment of a platform at district level. The identified site should be confirmed with clear set of criteria agreed by key stakeholders (Step 1: Create a platform at district level to obtain buy-in from key stakeholders)

For implementing the DEM approach, the importance of a working group consisting of persons with disabilities, governments, municipalities and other key stakeholders are confirmed. They as a team work together towards addressing barriers to participation of persons with disabilities at local municipality level. (Step 2: Establish a working group at local municipality level to guide and oversee the implementation process)

Next, working group members are empowered and capacitated to implement activities using the DEM approach. Firstly, the member with disabilities should first be empowered through the training to enhance their understanding of disability based on social model perspective. Then the trained persons with disabilities conduct disability awareness activity for all working group members so that the members understand social model of disabilities (Step 3: Conduct training to empower the working group).

The barriers to participation identified by the working group should reflect enablers to participation of persons with disabilities. These barriers should be extracted from the baseline survey including questionnaire responses, to genuinely listen to the voices of persons with disabilities in the implementation site. Then the working group develops an activity plan based on results of the baseline survey by discussing at the DEM introductory workshop (Step 4: Conduct a baseline survey and develop an activity plan based on results of the survey).

The working group in collaboration with key stakeholders implements the planned activities (Step 5: Implement planned activities by the working group), and monitor and evaluate these activities (Step 6: Monitor and evaluate in collaboration with three spheres of government and DPOs). It should be noted that monitoring and evaluation is very important in analysing the issues and challenges, such as a delay in the implementation of the activity plan. Based on the results of the monitoring and evaluation, the working group will be able to take appropriate measures to solve the issues and challenges, continue activities, and develop a new activity plan.

One of key success factors on the activity implementation is that three spheres of government, the working group and key stakeholders such as DPOs have a common understanding in planning, implementation and monitoring.

Following these steps enables persons with disabilities to actively participate in the implementation of disability mainstreaming at district and local level. In addition, the implementation steps follow the DEM approach's concept, i.e. 1) putting persons with disabilities and their families first and centre; 2) developing government capacity and systems; and 3) creating inclusive communities through practical activities.

Conducting the six steps in the order explained above is recommended. However, the steps and activities can be adjusted and customised depending on the situation at an implementation site. For instance, if stakeholders agree to use the existing structure as a working group for the DEM approach, they can utilise it without establishing a new working group. Also, if stakeholders realise the need for more capacity building training for the working group, the additional training can be organised even after the commencement of the planned activities. The implementation steps of the DEM approach should be flexible.

An important reminder is that at every step of this process, persons with disabilities and their families should be placed first and centre, and be active members of all discussions, decisions and activities.



The implementation steps of the DEM approach are reflexive and dynamic so steps can be returned to or skipped if needed

## IMPLEMENTATION STRUCTURES

---

The DEM approach requires inter-sectoral collaboration and coordination between a range of stakeholders across various sectors. The establishment of formal structures enables all stakeholders to collaborate and coordinate to respect each specific role.

A platform is created at district level to gain buy-in from key stakeholders for implementing the DEM approach. The stakeholders at district level, such as district departments, district municipalities, representatives of DPOs at district level, etc., have an overall responsibility for implementing activities, especially the identification of implementation sites and coordinating the activity implementation.

A working group is established at local municipality level to guide and oversee the implementation process. The members consist of persons with disabilities and representatives of the disability sector in the implementation site, officials of the relevant departments, local municipality, and other stakeholders. Key departments and the municipality should be involved in the working group from the beginning. The working group is established at local municipality level for implementing the activities efficiently and expeditiously.

Provincial government and departments play roles in the supervision of the implementation of activities and provision of technical advice to districts. Furthermore, provincial governments/departments have significant roles in expanding the activities by building partnerships with relevant departments, municipalities and DPOs, and rolling out the DEM approach in other districts in the province. For instance, the Office of the Premier has a responsibility for coordinating cross-cutting strategic government initiatives. As disability is one of the cross-cutting issues, the Office of the Premier can coordinate efforts to expand the DEM approach in other districts. Provincial DSD also should roll out the DEM approach in other districts.

Provincial government and departments also have the responsibility of reporting the results of monitoring of the activities to national governments and departments.

National government and departments play roles in the supervision and provision of necessary advice to provincial, especially regarding coherence with related policies.

The structures should be aligned with the District Development Model which aims to accelerate, align, and integrate service delivery under a single development plan per district or metro that is developed jointly by national, provincial and local government.

### Department of Social Development

Officials of the Department of Social Development (DSD), as the lead department on social issues, inclusive of social protection and community development services for persons with disabilities and their families, have responsibilities for facilitating, coordinating, managing and monitoring the implementation of activities using the DEM approach.

National DSD provides advice on how to use the DEM guidelines as an organisation which developed the guidelines.



## Local government

Local government is the sphere of government closest to the people in community. Many basic services (e.g. water, sanitation, electricity, health services, transport, etc.) are delivered by local municipalities. They also communicate with various departments to address different issues including disability at local level.

The DEM approach places value on interventions in communities to realise the equality and full participation of persons with disabilities in all aspects of their lives. For this reason, it is very important to align with the structures of local government and involve them in the activities.

## COGTA

The mission of Cooperative Governance and Traditional Affairs (COGTA) is to ensure that all municipalities perform their basic responsibilities and functions consistently. As disability mainstreaming should be addressed by all governments and municipalities, the COGTA should ensure that municipalities accelerate disability mainstreaming as their mandate. In addition, the COGTA implements disability mainstreaming in the existing programmes in their own department such as the Community Work Programme (CWP) which provides a job safety net for unemployed people.

## SALGA

South African Local Government Association (SALGA) is an autonomous association of all 257 South African local governments, comprising a national association.

SALGA has a clear strategic role to play in representing the interests of local government within the system of government as a whole, while supporting its members to fulfil their developmental obligations.

SALGA has a significant role in involving municipalities in implementing the DEM approach at municipality level, based on the idea that the implementation of the DEM approach brings together the interests of local government and the fulfilment of their developmental obligations.

## DPOs

Pillar 6 of the WPRPD: Strengthening the Representative Voice of Persons with Disabilities, directs “[the inclusion of] persons with disabilities in all design, planning, implementation and monitoring of policies and programmes”. Pillar 6 also states that “Government institutions at all levels and contexts of governance must consult relevant representative organisations of persons with disabilities (inclusive of parent organisations) in the design, budgeting, implementation and monitoring of legislation, programmes and services to the public in general, as well as services and programmes designed specifically for persons with disabilities.”

DPOs should be involved in all steps, from planning to monitoring.

## Roles of key stakeholders in each implementation step of DEM approach

### **STEP 1: Create a platform at district level to obtain buy-in from key stakeholders**

- District DSD and district municipality discuss how to create a platform for commencement of the DEM approach, in consultation with provincial DSD and the Office of the Premier.
- District DSD and district municipality invite all district departments, district representatives of disability sector including DPOs to a meeting for: 1) introduction of the DEM approach and the guidelines; 2) identification of an implementation site; and 3) gaining buy-in to begin the DEM approach in the identified implementation site.
- Portfolio committee meetings are good opportunities to introduce the DEM approach. The opportunity of using this meeting is helpful to ensure the smooth implementation and to accelerate disability mainstreaming in other sectors.

### **STEP 2: Establish a working group at local municipality level to guide and oversee the implementation process**

- District DSD, district and local municipalities in the implementation site have a meeting with key stakeholders at local municipality level to establish a working group. Officials of all district departments who are in charge of the implementation site and representatives of disability sector and DPOs in the implementation site should participate in the meeting. All stakeholders discuss and confirm the working group members.
- Local ward councillors and community development workers/practitioners who are in the structure of the municipality should be involved in this meeting as the focal people in municipalities closest to communities. In addition, it is recommended to involve representatives of the disability forum as working group members. Some municipalities organise a disability forum in a district and/or at local municipality level regularly to discuss problems faced by persons with disabilities.

### **STEP 3: Conduct a training to empower the working group**

- The working group conducts and participates in training to understand disability from the social model perspective. DSD provides training resources such as trainers and materials. A venue, catering, and transport are provided by municipalities, DSD and other organisations of the working group.

### **STEP 4: Conduct a baseline survey and develop an activity plan based on results of the survey.**

- District DSD in collaboration with the local municipality and disability sector conducts a baseline survey targeting persons with disabilities in the implementation site.
- To develop an activity plan, the working group organises and participates in a DEM introductory workshop. District DSD in collaboration with national and provincial DSD facilitates the workshop so that the working group members develop an activity plan based on results of the baseline survey. The venue, catering and transport should be covered by organisations of the working group such as municipalities and DSD.

### **STEP 5: Implement planned activities by the working group**

- The working group in collaboration with key stakeholders implements planned activities. Implementation costs including transport should be covered by organisations of the working group.



Persons with disabilities develop materials for a disability awareness activity (Free State)



Persons with disabilities and government officials discuss the accessibility of a SASSA office (KZN)



DSD official presents the background and outline of the project to stakeholders (Limpopo)



Working group comes together to discuss their roles and responsibilities (KZN)

- It is vital to involve a councillor responsible for Special Programmes so that key community persons (e.g. ward councillor, chief, headman, traditional leader, etc.) can be coordinated smoothly. Local ward councillors are also able to contribute to promoting the participation of persons with disabilities in existing community programmes such as the EPWP and CWP.

### STEP 6: Monitor and evaluate in collaboration with three spheres of government and DPOs

- The working group reviews the progress of the activities by themselves.
- District DSD and district municipality in collaboration with the local municipality and disability sector should monitor the activities frequently. District DSD and municipalities support and coordinate this if the working group requests intervention by government to progress the planned activities.
- Provincial DSD should visit the implementation site often to monitor implementation of planned activities and advise district DSD and the working group. Provincial DSD (basically, the provincial disability coordinator) populates the monitoring template and submits it to national DSD on a quarterly basis.



### WISDOM FROM PARTICIPANTS: Importance of buy-in from key stakeholders

“The Member of the Executive Committee (MEC) is a part of the structure from the beginning and is in a better position to support persons with disabilities. The MEC can push the activities and help us support persons with disabilities.”

– *Mamosa Motsoeng, director: Services to Persons with Disabilities, DSD Free State*

“Get the Office of the Premier involved as they oversee all the departments, so they can coordinate and give you support. Working with the relevant councillors in the municipality is critical – they know the local councillors, so they can identify the right people and make appointments on our behalf. Get buy-in from senior managers from the beginning, so consulting with officials (members of the working group from the different departments) individually at first is helpful.”

– *Johanna Thabathi, disability coordinator, DSD Limpopo*

“In our municipality, we went to the community, to chiefs, indunas and different stakeholders, introducing the programme and ensuring they understood. Before the commencement of the DEM approach, we didn't know how they could help disability issues, but now we realise the importance of the involvement of community leaders.”

– *Fungheni Mavuyisi, councillor of a special programme, Collins Chabane municipality*

# CREATE A PLATFORM AT DISTRICT LEVEL TO OBTAIN BUY-IN FROM KEY STAKEHOLDERS



## STEP 1

### Creating a platform

As the first step, a platform is created to achieve effective and efficient collaboration and coordination among stakeholders. The platform is an opportunity for a variety of stakeholders to communicate on how to act for the empowerment of persons with disabilities and disability mainstreaming. The platform plays a role in identifying key stakeholders and an implementation site for implementing the DEM approach. The platform also has the following roles:

- Provide information on the different resources available for implementing the DEM approach
- Discuss how to incorporate disability with consideration to all stages of government services/programmes and community development
- Share good practice on the implementation of the DEM approach in a variety of fields.

### Identifying an implementation site

It stands as essential that all municipalities should implement the DEM approach. However, for the purpose of focusing on the intervention of the implementation, an implementation site should be identified by showing appropriate reasons and compelling needs for implementing the DEM approach. For instance, you may find that some organisations or individuals show a real passion and commitment for using the DEM approach to solve the problems which persons with disabilities face, or some government officials take sound initiatives to integrate the DEM approach into an existing programme. District DSD and district municipality should, through a participatory process with a clear set of criteria agreed by everyone, coordinate the identification of an implementation site. These processes should be managed by district DSD and district municipality in consultation with provincial governments and departments.



### COMMON KEY IMPLEMENTATION CRITERIA AND SUSTAINABILITY FACTORS FOR SELECTING AN IMPLEMENTATION SITE

The following points can be referred to in identifying pilot sites:

- Willingness/commitment to implement the DEM approach
- Commitment level of DSD officials (e.g. district disability coordinator, community development practitioners, social workers, etc.)
- Commitment level of local government (e.g. mayor, municipal director/manager, ward councillors, disability forum, community leaders, traditional leaders, etc.)
- Existence of inter-governmental structures (e.g. Health, Education, Agriculture, Public Works, Transport, etc.)



## STEP 2

# ESTABLISH A WORKING GROUP AT LOCAL MUNICIPALITY LEVEL TO GUIDE AND OVERSEE THE IMPLEMENTATION PROCESS

After obtaining buy-in from the platform members, a working group is established at local municipality level. The establishment of a working group fulfils the aims of implementing the DEM approach efficiently and expeditiously. In addition, it provides an opportunity and a place to communicate equally among persons with disabilities, government officials and stakeholders at the implementation site.

### Functions of a working group

The functions of a working group are as follows:

- To develop an activity plan and implement the planned activities in the implementation site
- To discuss technical and practical matters concerning activity implementation
- To review the achievements of the activity plans, and report to district government and departments
- To discuss solutions to major issues arising from or in connection with the activity implementation, and to respond with appropriate measures
- To discuss any other issues relevant to the smooth implementation of the planned activities.

### Expected members of a working group

A working group should consist of persons with disabilities in the implementation site, representatives of DPOs, officials of departments/municipalities, and other stakeholders. It is recommended to appoint the members formally to obtain the strong commitment of each member and sustain the working group. For instance, members should be appointed with an appointment letter from the Head of Department (HOD) of the provincial DSD. In addition, it is recommended that the terms of reference (TOR) of a working group be developed and approved by the members to obtain a common understanding and consensus on the functions of the working group. An example of the TOR is included as Tool 1.

The following specific persons are recommended for appointment to the working group:

- Persons with disabilities in the implementation site
- Representatives of DPOs of persons with various types of impairment in the implementation site
- Disability coordinators in provincial and district DSD as convenors/advisors
- Social workers from the district DSD
- Focal persons of the Office of the Premier, district and local municipalities
- Councillors responsible for Special Programmes and ward councillors
- Members of a disability forum in district and local municipalities
- Focal persons in relevant departments such as Basic Education, Health, Public Works, Labour, SASSA, etc. at district level.
- Sector departments from within the municipality such as community services, social development, local economic development, housing, transport, water and sanitation, energy, municipal infrastructure, land reform, spatial planning, etc.

It is important to involve as many stakeholders as possible to expand disability mainstreaming. However, it is cautioned that the more members of a working group, the more difficult to coordinate the availability of members. It might be wise to start with the most important stakeholders (fewer than 20 people) for the working group. Then, when need arises, other important stakeholders can be invited later.

Another important reminder is that the composition of the group should be carefully considered so that members with disabilities can participate actively in the working group and express their opinions freely with other members. For instance, the members with disabilities might hesitate to voice their opinions if they are a minority in the working group.

The way in which a working group is configured has a strong influence on the working group's performance and outcomes. The platform members should discuss with key stakeholders at the implementation site to decide who should be a working group member.

## **TOOL 1** (PG 58)

**EXAMPLE OF TERMS OF REFERENCE OF A WORKING GROUP FOR IMPLEMENTING THE DEM APPROACH**



### **PREPARING FOR EVENTS AND ACTIVITIES**

When you include persons with disabilities in the activities/events, several factors should be taken into account to ensure that all persons with various types of impairment are catered for. Here is a checklist of considerations for activity organisers in their preparations:

- The venue should be accessible for persons with disabilities (e.g. ramps, lifts, accessible toilet facilities, adequate parking space, adequate lighting, etc.)
- Reasonable accommodation should be provided (ask persons with disabilities what kind of support they need) – this includes Braille documents, enlarged print documents, sign language interpreters, accessible transport, etc.
- The presentations and other documents of the meeting should be sent to participants in advance, as persons with visual impairments will need time to digest the information ahead of time
- Consider proximity to public transport nodes
- Ensure that the meeting time is convenient for participants who are travelling, by consulting with them about their needs.





## STEP 3

# CONDUCT TRAINING TO EMPOWER THE WORKING GROUP

A capacity building training session is conducted for the working group. This is designed for them to become empowered, and to enable them to participate positively in the development of the activity plan and implementation of the activities through understanding of disability. There are two different types of capacity building training. One is training for the members with disabilities to enhance their understanding of disability based on the social model perspective (peer counselling and Disability Awareness Facilitator Training). The other is a disability awareness activity for all working group members, facilitated by the trained working group members with disabilities (Disability awareness activity).

### **1 TRAINING FOR WORKING GROUP MEMBERS WITH DISABILITIES: PEER COUNSELLING AND DISABILITY AWARENESS FACILITATOR TRAINING**

#### Objectives

- To empower the working group members with disabilities to lead the development of the activity plan and participate actively in the working group
- To capacitate the working group members with disabilities to facilitate disability awareness activities in the DEM introductory workshop.

#### Target participants

- Working group members with disabilities in the implementation site are the intended participants
- The number of participants is recommended to be fewer than 15 people for a well-managed training session and for achieving the objectives.

#### Organisers

Organisers are drawn from district DSD and municipalities, in collaboration with the working group and provincial DSD. The recommended demarcation of responsibilities is as follows:

- a) District DSD and municipalities in collaboration with provincial DSD and the working group:
  - Nominate participants with disabilities
  - Arrange accessible venue, transport for participants, and catering
  - Communicate and coordinate with trainer(s)
  - Dispatch trainer(s) (in consultation with national DSD, if needs arise)
- b) Trainer(s)
  - Develop a programme and materials
  - Facilitate the training
  - Develop a training report and submit it to the organisers.

### Programme example

The training comprises two main components: 1) Peer counselling (Day 1); and 2) Disability Awareness Facilitator Training (Days 2–3) – in total, three days of training for working group members with disabilities.



After this training, trained participants facilitate disability awareness activities for all working group members. (For further information on the disability awareness activities, please refer to 2. Training for working group members: Disability awareness activity on page 24.)

### Day 1 (Peer counselling)

DAY 	TIME 	PROGRAMME 
<b>DAY1</b>	10h00–10h20	Welcome and introductions
	10h20–10h30	Purpose of peer counselling
	10h30–10h50	What is peer counselling?
	10h50–11h20	Relation building
	11h20–11h40	New and good
	11h40–12h10	Nature of human beings
	12h10–12h40	Discharge of emotion
	12h40–13h30	Lunch
	13h30–14h05	Peer counselling 1
	14h05–14h35	Disability
	14h35–15h05	Appreciation
	15h05–15h25	Good and learn
	15h25–15h30	Way forward and closing



## Days 2 and 3 (Disability Awareness Facilitator Training)

DAY 	TIME 	ITEM 
DAY 2	10h00–10h20	Purpose of the training
	10h20–12h30	Demonstration of disability awareness activity by the trainer
	12h30–13h30	Lunch break
	13h30–15h00	How to conduct disability awareness activity <ul style="list-style-type: none"> <li>• Detailed explanation of each exercise</li> <li>• Activity examples including introduction of materials</li> </ul>
	15h00–16h00	Q & A
DAY 3	10h00–10h30	Recap of Day 2 of the workshop
	10h00–12h00	Practice of disability awareness activity by participants
	12h00–13h00	Lunch break
	13h00–15h00	Practice of disability awareness activity by participants
	15h00–15h50	Discussion of how to demonstrate disability awareness activity in DEM introductory workshop <ul style="list-style-type: none"> <li>• Allocate each role</li> <li>• How to conduct time management</li> </ul>
	15h50–16h00	Way forward and closing

### PROGRAMME 1: Peer counselling

Peer counselling is a strong and effective tool for empowerment of persons with disabilities. 'Peer' means a person who is of equal standing to another person, and who has a similar background. Persons with disabilities listen and speak to the challenges and needs of one another as equals.

#### Objectives of peer counselling

- Through peer counselling, persons with disabilities heal the pains from various social disadvantages to recover self-reliance and rebuild human relationships
- Peer counselling aims to empower persons with disabilities to become independent, be part of community and participate in any social activities.

#### Method

- Peer counselling for persons with disabilities is about getting help from a trained peer counsellor who also faces disability
- Peer counselling can involve one-on-one or group counselling, depending on the needs of the participants
- Peer counselling is different from general counselling because those doing the counselling have direct experience of disability (i.e. a person with a disability can be a peer counsellor, while a person without a disability can only be a counsellor).

## Reasons why peer counselling is facilitated by persons with disabilities

- 'Peer' means colleagues or persons who have a similar background. Persons with disabilities can share knowledge, experiences, challenges, and offer emotional, social and practical support to one another on an equal basis
- Persons with disabilities have a much better understanding of what disability is, and can more easily relate to their peers
- Persons with disabilities feel more open when they talk to other persons with disabilities
- There is no person without disability (including personal assistants) when peer counselling is conducted. This helps the participants build confidence by seeing that they are not depending on anybody who is not in the same position as them
- The participants help one another in peer counselling. They recognise that persons with disabilities can support one another better than any others.

## Peer Counsellor Training

Peer counselling is facilitated by a trained person with disability who has attended the appropriate Peer Counsellor Training. A good peer counsellor is able to listen, empathise, identify problems, provide actionable solutions, and has the knowledge necessary to empower those who participate in peer counselling.

Peer Counsellor Training is conducted for three or four days to capacitate potential leaders with disabilities to facilitate further peer counselling. The materials for Peer Counsellor Training are presented in Tools 2, 3 and 4.



### WISDOM FROM PARTICIPANTS: Peer counselling

“The purpose of peer counselling is to empower each other and help people to gain confidence. Most people have challenges with family members because they become very protective. For example, they don't want persons with disabilities to be in relationships. Peer counselling guides us to help each other all the time to gain our self-confidence.”

– July Mathebula, peer counsellor

### TOOL 2 (PG 60)

FACILITATION GUIDE ON PEER  
COUNSELLOR TRAINING



### TOOL 3 (PG 68)

PRESENTATION ON PEER  
COUNSELLOR TRAINING



### TOOL 4 (PG 72)

MATERIALS ON PEER  
COUNSELLOR TRAINING



## PROGRAMME 2: Disability Awareness Facilitator Training

Disability Awareness Facilitator Training aims to train persons with disabilities to be facilitators of disability awareness activities. The disability awareness activity aims to promote the social model of disability to change society to an inclusive one. The social model of disability says that disability is in society and not in a person, and that the solution to disability is not changing person but changing society. The social model of disability is a key perspective in promoting the DEM approach.

The disability awareness activity is conducted through an interactive and participatory method so that participants 'discover' disability from the social model perspective for themselves.

## Objectives of Disability Awareness Facilitator Training

- To deepen understanding of the social model of disability
- To learn how to facilitate disability awareness activities through practice.



### **TOOL 5** (PG 82)

FACILITATION GUIDE ON  
DISABILITY AWARENESS  
FACILITATOR TRAINING



### **TOOL 6** (PG 92)

PRESENTATION ON DISABILITY  
AWARENESS ACTIVITY

### Reasons why the disability awareness activity is facilitated by persons with disabilities

Persons with disabilities have experience of disability from the social model perspective, such as the experience of discrimination. Persons with disabilities share their experiences of disability with participants, and the participants come to understand what disability is through dialogue with facilitators with disabilities.

Materials for Disability Awareness Facilitator Training are included as Tool 5 and Tool 6.

## **2 TRAINING FOR WORKING GROUP MEMBERS: DISABILITY AWARENESS ACTIVITY**

All working group members participate in the disability awareness activity to understand the social model of disability, which is a key perspective in promoting the DEM approach.

The disability awareness activity is facilitated by working group members with disabilities.

The members with disabilities should have been trained as disability awareness facilitators **before** this activity (see 1. Training for working group members with disabilities in Step 3 on page 20).

### Organisers



Organisers are drawn from district DSD and municipalities, in collaboration with the working group. The recommended demarcation of responsibilities is as follows:

- a) District DSD and municipalities in collaboration with the working group:
  - Arrange accessible venue, transport for participants, and catering
  - Communicate and coordinate with participants (i.e. the working group members)
- b) Facilitators (the trained members with disabilities)
  - Develop a programme and materials
  - Facilitate the activities.

### Programme example

The disability awareness activity comprises five exercises and uses an interactive and participatory method so that participants 'discover' disability from the social model perspective for themselves. The length of the activity requires a minimum of two hours.

The following programme gives an example of a three-hour session.

TIME 	PROGRAMME 
10h00–10h20	Welcome and introductions
10h20–10h30	Purpose of today's activities
10h30–10h50	Exercise 1: What is disability?
10h50–11h30	Exercise 2: What is disability? / Where is disability?
11h30–11h50	Exercise 3: What is disability?
11h50–12h20	Exercise 4: How do you solve?
12h20–12h40	Exercise 5: Listen to the voices of persons with disabilities
12h40–13h00	Conclusion and Q & A

Presentation on disability awareness activity is included as Tool 6.

**TOOL 6** (PG 92)  
PRESENTATION ON DISABILITY  
AWARENESS ACTIVITY



### WISDOM FROM PARTICIPANTS: Disability awareness activity

“I experienced an incident that left me with a disability. So understanding the difference between the medical and the social model of disability changed my mindset completely. I became comfortable with my impairment for the first time. The training gave me more power to understand and be able to fight for my rights as a person with disability.”

– *Miranda Lephoko,*  
*Disability Equality Training (DET) facilitator*

“Before the training, I was a bit in the dark. I couldn't understand what disability is. After being trained, I realised that disability is not within a person but in society and how people deal with us. Now I can socialise, know my rights as person with disabilities, and how to include persons with disabilities regardless of types of impairment.”

– *Grace Waterboer, person with albinism*

“When I first participated in the Disability Awareness Facilitator Training I was so shy and rarely talked in the training. On Day 3, all participants went to a village for a practical exercise to show their learning to the villagers, including persons with disabilities. I tried to be confident and started to explain what I had learned. The ideas I learned in the training were actually eye-opening for me and in the back of my mind I was happy to have the opportunity to speak in front of people about the social model I wanted to advocate. I think I looked confident on the stage. One member of the audience, a woman with disability, seemed to be especially impressed by my speech. I had never experienced people praising me and was delighted. I think my courage must have moved people's hearts and I was also moved by people. Helping others itself empowered me and produced a virtuous circle. I will continue to advocate the social model of disability in my community.”

– *The late Sarikie Madingana, person with disability*



## STEP 4

# CONDUCT A BASELINE SURVEY, AND DEVELOP AN ACTIVITY PLAN BASED ON RESULTS OF THE SURVEY

### 1 CONDUCT A BASELINE SURVEY

The baseline survey is conducted to collect the necessary information and analyse the situation (status quo) concerning barriers and needs of persons with disabilities in the implementation site. The information collected in the survey is intended to inform and develop an activity plan based on their needs.

#### Objectives

- To identify and analyse the barriers faced by persons with disabilities and their needs in the implementation site
- To assist in designing an activity plan to address the identified barriers.



#### HELPFUL REMINDERS FOR QUESTIONNAIRE SURVEY

- Translate the questionnaire into the local language (if necessary)
- Carefully read out the questions in the questionnaire to respondents for their better understanding
- Consider a range of types of impairment and gender representation in selecting respondents
- Ensure that the respondents understand their right not to answer certain questions
- Provide personal assistants to fill in the questionnaire for persons who have difficulty writing because of their impairment
- Identify and cooperate with a person who is familiar with the disability sector in the implementation site to assist in finding persons with disabilities who can and are willing to respond to the questionnaire.

#### Organisers

Organisers can be drawn from district DSD disability coordinators and social workers, in collaboration with the local municipality, disability sector and the working group.

#### Questionnaire survey

A questionnaire survey is conducted for persons with disabilities in the implementation site to identify their challenges and the needs that need to be addressed. It is recommended that at least 30 persons with disabilities in the site participate in the survey and complete the questionnaire. After collection of answered questionnaires, the information is populated in an Excel template to analyse the results of the questionnaire survey. The questionnaire form appears as Tool 7.

#### Supplementary surveys

Interviews, group discussion and desktop surveys are also useful to obtain additional information for the status quo analysis. Supplementary surveys should also consider types of impairment and the gender of respondents.

Desktop surveys are helpful to collect basic information such as the number of persons with disabilities based on each impairment. This number can be collected from Census 2011, Community Survey 2016, and the Integrated Development Plan (IDP) of each municipality. The results of the Census and Community Survey can be downloaded from the website of Statistics South Africa (StatsSA) at: <http://www.statssa.gov.za/>.

It is also recommended to collect the following stakeholder information:

- List of DPOs/NGOs in the implementation site
- Information on disability focal persons in relevant departments, districts and local municipalities
- Disability forum
- Councillors or facilitators of special programmes
- DSD facilities relating to disability (e.g. residential facility, Skills and Work Centre (previously known as protective workshop), etc.)
- Other DSD facilities (e.g. Child and Youth Care Centre, Drop In Centre, centre for older persons, etc.)
- Schools (including special schools)
- Early childhood development programmes and centres.

### Analysis and compilation of results of the baseline survey

Strong barriers, challenges and needs are identified by analysing the answered questionnaires. District disability coordinators in collaboration with the working group compile a report on the results of the baseline survey and share it in the DEM introductory workshop.

All issues identified by the baseline survey should be shared by all working group members. In the DEM introductory workshop, the working group, including the members with disabilities, discuss what barriers/needs should be addressed and develop an activity plan to address those barriers. An example of a report on the results of the baseline survey is included in Tool 4.



Persons with disabilities fill in the questionnaire survey (Limpopo)



A government official assists a person with disability to fill in the questionnaire survey (Free State)

**TOOL 7** (PG 104)  
QUESTIONNAIRE FORM FOR BASELINE SURVEY



**TOOL 8** (PG 110)  
EXAMPLE OF REPORT ON RESULTS OF THE BASELINE SURVEY





## 2 DEVELOP AN ACTIVITY PLAN IN THE DEM INTRODUCTORY WORKSHOP

The DEM introductory workshop is conducted for the purpose of development of an activity plan to commence activities using the DEM approach.

### Objectives

- To understand the DEM approach and begin activities using the DEM approach
- To develop an activity plan to address barriers faced by persons with disabilities.

### Target participants

DEM working group members from the implementation site are the intended participants.

### Organisers



Organisers are drawn from district DSD and municipalities, in collaboration with the working group and provincial DSD. Roles of the organisers are as follows:

- a) District DSD and municipalities in collaboration with provincial DSD and the working group:
  - Arrange accessible venue, transport for participants, and catering
  - Communicate and coordinate with the working group members, and invite them as the participants
  - Develop a programme and materials
  - Facilitate the training
  - Develop a training report and share it with the stakeholders.
- b) Provincial/district DSD (consultation with national DSD if the need arises)
  - Develop a programme and materials
  - Facilitate the workshop.



Persons with disabilities, social workers and transport sector stakeholders develop an activity plan to improve the accessibility of transport (Limpopo)

## Programme example

<b>DAY</b> 	<b>TIME</b> 	<b>ITEM</b> 
<b>DAY 1</b>	10:00–10:20	Welcome and introductions
	10:20–12:00	Overview and concept of the DEM approach <ul style="list-style-type: none"> <li>• Three fundamental principles</li> <li>• Implementation steps</li> <li>• Social model of disability (recap of disability awareness activity)</li> <li>• DEM activity examples</li> </ul>
	12:00–13:00	Lunch break
	13:00–13:30	Report on results of the baseline survey
	13:30–14:00	Presentation on the action plan template
	14:00–15:00	Identification of strong barriers to participation for persons with disabilities in the implementation site
	15:00–16:00	Development of activity plans
<b>DAY 2</b>	10:00–10:15	Recap of Day 1 of the workshop
	10:15–12:00	Development of activity plans (continue from where we left off yesterday)
	12:00–13:00	Lunch break
	13:00–14:00	Presentation of activity plans
	14:00–15:00	Consolidation and finalisation of activity plans
	15:00–15:30	Confirm next activity with concrete timeframe
	15:30–	Way forward and closing



## Programme content

The programme has two main components: 1) Overview of the DEM approach; and 2) Development of activity plan based on the results of the baseline survey. For specific content, refer to Tools 9, 10, 11 and 12.

### Overview and concept of the DEM approach

Facilitator (provincial/district DSD official) explains and gives an outline of the DEM approach such as the concept, implementation steps and activity examples, as well as the relevant policy framework. In addition, the facilitator explains the social model of disability which is a key perspective in promoting the DEM approach.

### Report on results of baseline survey and identification of strong barriers at the implementation site

This report aims to establish a common understanding among the working group members on the current status, barriers and needs of persons with disabilities in the implementation site, in order to develop an activity plan. The participants become aware of several strong barriers identified as the priority areas to be addressed through the results of the baseline survey.

### Development of an activity plan based on results of the baseline survey

The development of an activity plan is one of the essential elements of the DEM approach. The participants develop an activity plan to address the identified barriers in the implementation site. So that all participants are actively involved in the development of the activity plan, participants are recommended to divide into small groups (fewer than eight people in the group and considering the balance of persons with and without disabilities). Then in the session on presentation of activity plans, developed activity plans by each small group are shared with all participants. Lastly, all participants discuss, consolidate and finalise the activity plan.



#### **TOOL 9** (PG 112)

FACILITATION GUIDE ON DEM INTRODUCTORY WORKSHOP: TO DEVELOP AN ACTIVITY PLAN



#### **TOOL 10** (PG 122)

PRESENTATION ON DEM INTRODUCTORY WORKSHOP



#### **TOOL 11** (PG 130)

ACTIVITY PLAN AND MONITORING TEMPLATE



#### **TOOL 12** (PG 132)

EXAMPLE OF DEVELOPED ACTIVITY PLAN



## STEP 5

# IMPLEMENT PLANNED ACTIVITIES BY THE WORKING GROUP

The working group in collaboration with key stakeholders commence the planned activities after the DEM introductory workshop. This step shows what activities were implemented in the study sites. The experience of the study sites can be used to refer to and applied in implementing the DEM approach at any other sites or areas.

### **SITE 1: Collins Chabane municipality, Vhembe district, Limpopo province**

#### **A working group and an activity plan**

The working group was established in Collins Chabane. The members were officially appointed by the HOD of DSD. In November 2016, the working group discussed and developed an activity plan. As a result of the discussions, the members recognised the need for empowerment of persons with disabilities in communities as a first priority. They developed an activity plan to implement the following activities to empower persons with disabilities:

- Conduct Peer Counsellor Training for persons with disabilities
- Conduct Disability Awareness Facilitator Training
- Trained peer counsellors conduct peer counselling in a number of villages
- Establish community-based empowerment group (CEG) of persons with disabilities in each identified village.

The working group, through the intervention and assistance of the local municipality and ward councillors, successfully conducted peer counselling for about 500 persons with disabilities in 22 villages. The process was as follows:

- The working group obtained the approval of community leaders such as ward councillors and traditional leaders before conducting peer counselling in villages
- Before peer counselling, the working group conducted a disability awareness activity in order for community leaders to understand disability and the importance of peer counselling
- The community leaders recommended/nominated persons with disabilities to participate in peer counselling and then conducted peer counselling for selected participants with disabilities.

#### **Community-based empowerment group (CEG)**

Through peer counselling sessions, the participants identified their potential/capability, their needs and challenges, and then established a committee that will lead the group, namely the community-based empowerment group (CEG, alternative name for Self-Help Group) in each community.

#### **Sustainability of the CEG**

After the establishment of the CEG, the participants faced the challenge of the sustainability of the groups. Some CEGs are not currently working for several reasons (e.g. it is difficult to obtain the approval of community leaders to continue an activity; some members were unable to avail themselves for CEG activities because they were busy working or participating in a learnership, etc.) As the reality of the situation emerged, they discussed how to sustain and strengthen the CEG, and realised that the committee should give this group a name, construct objectives, develop a constitution, decide on an area of operation, and apply for registration of the entity in the DSD NPO directorate.

The CEG members decided to establish a federation of CEGs which coordinates several CEGs. The federation has been registered as a non-profit organisation (NPO) to apply for funding sources in order to strengthen and sustain the activities of the CEG.

The provincial DSD and Vhembe district DSD continues the DEM activities as their mandate, and they encourage other districts to roll out the DEM approach.

### **Roll-out of DEM approach to other districts**

Currently, the provincial DSD has started to roll out the DEM activities in other districts based on the project experience in Vhembe district. The provincial disability coordinator conducted disability mainstreaming training using the DEM approach and resources developed by the DEM project. The training was conducted at all five districts for social workers, Skills and Work Centre (SWC, formerly protective workshop) managers and other stakeholders. In addition, in January 2020, the provincial DSD commenced the DEM activities in Greater Giyani municipality, Mopani district. They are implementing the activities in reference to the DEM implementation steps: 1) Establish a platform and working group; 2) Conduct a baseline survey; 3) Capacity building training for persons with disabilities; 4) Develop an activity plan in the DEM introductory workshop; 5) Implement the planned activities.

### **SITE 2: Maluti-a-Phofung municipality, Thabo Mofutsanyana district, Free State province**

In January 2019, stakeholders of the DEM project developed an activity plan to promote the empowerment of persons with disabilities and improve accessibility through the following activities:

- Conducted peer counselling in a number of villages for community-based empowerment groups with an average of 8–12 participants per group per session
- Sensitised communities and stakeholders about the social model of disability through a disability awareness activity
- Conducted an access audit at government buildings.

To implement the above-mentioned activities, three training sessions were first conducted: Peer Counsellor Training, Disability Awareness Facilitator Training, and Access Auditor Training. After the training, a total of 67 trained persons with disabilities in collaboration with relevant departments conducted peer counselling, disability awareness activities in villages, and access audits at the DSD district office, local municipality office, South African Social Security Agency (SASSA), and community halls. As a result of the access audit, two accessible community halls were constructed by the Department of Public Works (DPW).

In October 2019, provincial DSD in collaboration with national and district DSD used the DEM approach for promoting disability mainstreaming in the Child and Youth Care Centre (CYCC). They organised disability mainstreaming training at Leratong CYCC for social workers, caregivers and other stakeholders. Provincial DSD plans to conduct similar training for CYCCs in other districts to roll out disability mainstreaming in CYCCs.

These two cases (accessible community halls and training at CYCC) are shown in Part 5 on good practice, with further information provided.

### **SITE 3: Nyandeni municipality, OR Tambo district, Eastern Cape province**

In August 2019 at the DEM introductory workshop, the working group discussed and chose four burning issues to be addressed which had been identified through the baseline survey. The identified challenges included: accessibility of government buildings, transport, empowerment of persons with disabilities, and health services. They developed activity plans with the following objectives:

**OBJECTIVE 1** Improve accessibility of DSD Libode

**OBJECTIVE 2** Sensitise the Nyandeni taxi association on the issue of disability

**OBJECTIVE 3** Conduct disability awareness activity on the rights of persons with disabilities

**OBJECTIVE 4** Improve dissemination of information on accessibility of health services.

Regarding objectives 2 and 3, Disability Awareness Facilitator Training was organised by the DSD in September 2019. A total of 15 persons with disabilities were capacitated to conduct disability awareness activities. A practical disability awareness activity was conducted at the albinism awareness event in Nyandeni municipality. This activity was realised by collaborating with district DSD and the Albinism Society of South Africa (ASSA). For the next activities, the working group is planning to conduct a disability awareness activity for various target groups such as the community, departments, NGOs, taxi associations, etc.

In order to promote the empowerment of persons with disabilities in objective 3, Peer Counsellor Training was organised in November 2019 by DSD in collaboration with the district municipality. A total of 17 persons with disabilities were capacitated to conduct peer counselling through the training. For their next activities, the working group is planning to conduct peer counselling in the villages where the participants with disabilities come from.

### **SITE 4: Mandeni municipality, iLembe district, KwaZulu-Natal province**

In August 2019 at the DEM introductory workshop, the working group discussed and chose four strong barriers to be addressed based on the results of the questionnaire survey. The identified target areas were: employment, transport, education, and communication and information on community participation. Activity plans were developed with the following objectives:

**OBJECTIVE 1** Create employment opportunities for persons with disabilities

**OBJECTIVE 2** Sensitise the Mandeni taxi association on disability

**OBJECTIVE 3** Improve physical and information accessibility at Ethel Mthiyane Special School

**OBJECTIVE 4** Offer capacity building for public servants to improve communication and information accessibility.

Regarding objective 1, an existing database of persons with disabilities was updated to identify potential persons with disabilities for the opportunity of employment. Awareness raising events were conducted for the relevant departments in collaboration with the Office of the Premier and municipalities in November 2019.

Regarding objectives 2, 3 and 4, Access Auditor Training was organised by DSD in September 2019. A total of 22 working group members participated in the training, and later conducted practical access audits at DSD Mandeni office, Ethel Mthiyane Special School, and the SASSA office in Mandeni municipality. The working group submitted a report which explained the results of the access audit together with recommendations to the stakeholders. After the access audit, DSD Mandeni office's accessibility was improved by installing accessible parking and signage in large font.

In addition, through this collaborative activity, networking was created between the working group and the stakeholders. For instance, DSD officials of the working group advised schoolteachers on how to receive further government services for learners with disabilities

## EXAMPLE OF PRACTICAL ACTIVITIES: ACCESS AUDIT

---

The WPRPD (2015) highlights how accessibility lies at the heart of the right to human dignity and emphasises the significance of accessibility in strategic pillar 1 of the WPRPD: 'Removing Barriers to Access and Participation'.

An access audit examines the accessibility and usability of facilities and services for various barriers such as physical, information, communication and attitudinal barriers. The access audit identifies barriers and considers the means of eliminating or mitigating them.

### Objectives of access audit

- To understand the requirements by legislative framework of South Africa such as the WPRPD and Part S of the South African National Standards (SANS) 10400
- To understand the accessibility of facilities and services for persons with disabilities
- To obtain knowledge and skills to conduct access audits through practice.

### How to conduct an access audit

An access audit is conducted by a team consisting of the following trained persons:

- Persons with various types of impairment
- Specialists like an architect, civil engineer or urban planner
- Government officials including DSD and the Department of Public Works, etc.
- Stakeholders of the access audit's venue/services, such as the owner of the building/s.

The team develops an access audit plan and conducts the access audit using a checklist. After the access audit, the team develops a recommendation report and submits it to the stakeholders.

### Rationale for access audit being conducted by a team composed of persons with disabilities and other stakeholders

Each member of the access audit has a role and complements one another to achieve the purpose of the access audit. The roles of the members are:

- Person with various types of impairment: Explain and demonstrate difficulties as **users**
- Architect, civil engineer, urban planner: Explain the differences between the current situation, regulations/desirable situation, as **specialists** (e.g. they compare the current situation with the SANS)
- Government officials: Analyse gap between the current situation and existing policies on accessibility, as **government officials**
- Stakeholders of venue/services of access audit: Observe access audit and take action to improve accessibility, as **owners**.

## Access Auditor Training

An access audit is led by access auditors who are capacitated in the Access Auditor Training session. Persons with various types of impairment are recommended to become auditors so that they can audit accessibility from the multiple perspectives of a range of impairments, as users of the facilities and services.

Access Auditor Training is conducted in sessions over three or four days to capacitate potential leaders with disabilities and other stakeholders to conduct access audits. The programme content is aligned with the WPRPD and the SANS 10400. In the WPRPD, the following six focus areas are specified to be addressed in order to remove barriers to access and participation:

- Changing attitudes and behaviour
- Access to the built environment
- Access to transport
- Access to information and communication
- Universal design and access
- Reasonable accommodation measures.

The detailed content and materials for Access Auditor Training are included as Tools 13, 14 and 15.

**TOOL 13** (PG 134)  
FACILITATION GUIDE ON  
ACCESS AUDITOR TRAINING



**TOOL 14** (PG 154)  
PRESENTATION ON ACCESS  
AUDITOR TRAINING



**TOOL 15** (PG 186)  
MATERIALS FOR ACCESS  
AUDITOR TRAINING



**TOOL 15-1:** Simplified ramp gradient finder

**TOOL 15-2:** Access audit checklist

**TOOL 15-3:** Access audit report template



### WISDOM FROM PARTICIPANTS: Access audit

“Access Auditor Training takes about three or four days, and checks accessibility of facilities like toilets (most are not accessible), ramps (usually not the right gradient), parking (which needs to be big enough) and so on. We learned how to audit accessibility, and how to help people to engage with us. It’s quite practical, and it helped a lot of persons with and without disabilities.”

– *Corné Lubbe, access auditor*

“I was part of the Access Auditor Training and participated in an access audit. It was a real eye-opener – most facilities are not accessible to persons with disabilities, and I was not aware of the challenges they encounter. Even in a government office, they can’t do the most basic things. We visited some buildings which the Department of Public Works (DPW) is responsible for and encouraged artisans to consider accessibility.”

– *Andrew Ramohllokoane, chief artisan: DPW Free State*

“When I grew up, I would see people with disabilities, my mind will flood with many questions. But these questions did not bother me that much. It was in 2010 when my friend was involved in an accident and his spine was injured which resulted in him being paraplegic, this incident made me realise the challenges that persons with disabilities are faced with. I always wanted to assist but did not know how. Miraculously my department was invited to take part in the Access Auditor Training in the DEM project and I was one of people who were chosen to attend. Believe me, it is just minor challenges that we need to do in order to make them comfortable. Let’s mainstream disability!”

– *Thobeka Mthembu, control work inspector: DPW Free State*



# STEP 6

## MONITOR AND EVALUATE IN COLLABORATION WITH THREE SPHERES OF GOVERNMENT AND DPOS

At each step, monitoring and evaluation forms a vital part of the process to ensure that the activities are effective, all stakeholders are engaged with the process, activity plans are being implemented, and the activities are sustainable.

The results of monitoring and evaluation identify achievements, challenges, and any gaps between the planned activity and the current real situation. Monitoring and evaluation allows you to revise activity plans, and can be used to replicate best practice. This series of actions enables the working group to sustain their activities through utilising the DEM approach.

### Monitoring template

A template for monitoring was developed as a tool for systematic monitoring and evaluation of the planned activities. The template is combined with the activity plan template which is utilised for development of activity plans. Items in the template are: objectives, planned activities, targets, timeframe, costing or budget items, responsible persons, progress, reason for deviation, and corrective action (see Tool 11).

### ACTIVITY AND MONITORING TEMPLATE



**TOOL 11**

ACTIVITY PLAN AND MONITORING TEMPLATE

Project site (province, district, local municipality):

Date:

Problem statement:

Objective:

PLANNED ACTIVITIES	TARGETS	TIMEFRAME	COSTING OR BUDGET ITEMS	RESPONSIBLE PERSONS	PROGRESS	REASON FOR DEVIATION	CORRECTIVE ACTION





## Roles and responsibilities in monitoring and evaluation

Monitoring and evaluation should be conducted by involving the three government spheres and DPOs.

The working group reviews the progress of the activities by themselves as the actual implementers. They check whether the activity plan has been implemented and discuss taking appropriate measures to progress the planned activities.

If some members of the working group belong to certain organisations (e.g. DPOs, NGOs, etc.), it is a good opportunity to share knowledge about the DEM approach with their organisations, and to integrate the DEM approach in their programmes.

As the closest government department to the implementation site, district DSD in collaboration with local municipalities and the disability sector should monitor the activities frequently (e.g. weekly or bi-weekly). District DSD and municipalities support and coordinate it if the working group requests intervention by governments to progress the planned activities.

Provincial DSD should visit the implementation site often to monitor implementation of planned activities and advise district DSD and the working group (e.g. every few weeks or monthly). In addition, provincial DSD populates the monitoring template and submits it to national DSD on a quarterly basis. To create a sustainable reporting system, it is recommended that provincial disability coordinators report progress on the DEM activities using the monitoring template provided. This can be done in a provincial disability coordinator's meeting, which is held quarterly. The provincial disability coordinators exchange achievements and challenges with national DSD and other provincial disability coordinators, and then replicate good practice in other areas.



Various stakeholders (Office of the Premier, persons with disabilities and parents of children with disabilities) discuss together (KZN)



Persons with disabilities and government official develop a monitoring report together (Limpopo)



Working group member presents activity and monitoring plans (KZN)





Persons with disabilities and government officials discuss how to develop an activity plan (KZN)

# PART 4



A social worker presents a developed activity plan (KZN)

## RESOURCES REQUIRED



Adequate and appropriate resource allocations are critical factors for the success of continuous implementation of the planned activities. In Part 4, three kinds of resources are shown as the resources required, namely, human resources, training materials and financial resources.

## HUMAN RESOURCES

### Training trainers

To build capacity, extensive training of trainers is conducted: this takes the form of Peer Counsellor Training, Disability Awareness Facilitator Training, and Access Auditor Training. The following three persons with disabilities are active as trainers currently. (Please contact the Directorate of Services to Persons with disabilities in national DSD if you would like to get in touch with the trainers.)

- Mr July Mathebula, Remme-Los Independent Living Centre (ILC), Gauteng province: Trainer of Peer Counsellor Training and Disability Awareness Facilitator Training
- Ms Miranda Lephoko, Disabled People South Africa (DPSA), Gauteng province: Trainer of Disability Awareness Facilitator Training and Access Auditor Training
- Mr Corné Lubbe, Remme-Los ILC, Gauteng province: Trainer of Access Auditor Training and Peer Counsellor Training.

### Number of people trained

From May 2016 to February 2020, 219 persons participated in capacity building training as part of the DEM project at the four study sites; and 1163 persons participated in the activities facilitated by the trained persons. Please contact the relevant provincial DSD disability coordinator if you would like to get in touch with any of the trained persons with disabilities.



Peer counsellor explains outline and objectives of peer counselling (Eastern Cape)

## Materials for training and activities

The following materials have been developed through the DEM project and included in the DEM guidelines:

- TOOL 1** Example of TOR of a working group
- TOOL 2** Facilitation guide on Peer Counsellor Training
- TOOL 3** Presentation on Peer Counsellor Training
- TOOL 4** Materials on Peer Counsellor Training
- TOOL 5** Facilitation guide on Disability Awareness Facilitator Training
- TOOL 6** Presentation on disability awareness activity
- TOOL 7** Questionnaire form for baseline survey
- TOOL 8** Example of report on results of the baseline survey
- TOOL 9** Facilitation guide on DEM introductory workshop: to develop an activity plan
- TOOL 10** Presentation on DEM introductory workshop
- TOOL 11** Activity plan and monitoring template
- TOOL 12** Example of developed activity plan
- TOOL 13** Facilitation guide on Access Auditor Training
- TOOL 14** Presentation on Access Auditor Training
- TOOL 15** Materials on Access Auditor Training

## Financial resources

The following points should be considered for costing and budgeting in activities using the DEM approach:

- Costing and budgeting help the planning process by ensuring that the goals and activities are financially affordable and feasible
- Costing should be carefully considered within a feasible timeframe of the fiscal year budget schedule
- The budget should be clarified in line with the demarcation of stakeholders
- The budget should include the costs of any special needs such as reasonable accommodation when persons with disabilities participate in DEM activities (e.g. sign language interpreter, Braille documents, etc.).

### Estimating financial resources at each step in the DEM implementation flow







The following items would essentially need to be budgeted for in each activity:

- Venue
- Catering
- Transport
- Accommodation (if need arises)
- Communication (phone calls, email, etc.)



The following budget items are further required for activities at each step in the DEM implementation flow.

Further budget items required for activities

#	STEP	TYPE OF ACTIVITY	EXAMPLES OF BUDGET ITEMS
1	<b>Create a platform</b> 	Meeting	<ul style="list-style-type: none"> <li>• Venue and catering (if necessary)</li> <li>• Transport for participants with disabilities</li> </ul>
2	<b>Establish a working group</b> 	Meeting	<ul style="list-style-type: none"> <li>• Venue and catering (if necessary)</li> <li>• Transport for participants with disabilities</li> </ul>
3	<b>Capacity building for working group</b> 	Training	<ul style="list-style-type: none"> <li>• Venue and catering (if necessary)</li> <li>• Transport for participants with disabilities</li> <li>• Transport/flights for trainers with disabilities and their personal assistants (PA)</li> <li>• Accommodation for trainers with disabilities and their PAs</li> <li>• Training fee (honorarium)</li> <li>• Equipment/materials (refer to Tool 5 on page 84 and Tool 13 on page 135)</li> </ul>
4	<b>Baseline survey</b> <b>Develop an activity plan</b> 	Questionnaire survey Workshop	<ul style="list-style-type: none"> <li>• Venue and catering (if necessary)</li> <li>• Transport for participants with disabilities</li> <li>• Equipment/materials (refer to Tool 9 on page 113)</li> </ul>
5	<b>Implement planned activities</b> 	Community activity, meeting and others	<ul style="list-style-type: none"> <li>• Venue and catering (if necessary)</li> <li>• Transport for participants with disabilities</li> </ul>
		Training	<ul style="list-style-type: none"> <li>• Venue and catering (if necessary)</li> <li>• Transport for participants with disabilities</li> <li>• Transport/flights for trainers with disabilities and their PAs</li> <li>• Accommodation for trainers with disabilities and their PAs</li> <li>• Training fee (honorarium)</li> <li>• Equipment/materials (projector, laptop, hands out, training materials, etc.)</li> </ul>
6	<b>Monitoring and evaluation</b> 	Meeting	<ul style="list-style-type: none"> <li>• Venue and catering (if necessary)</li> <li>• Transport for participants with disabilities</li> </ul>



## SECURING A BUDGET FOR DEM ACTIVITIES

In securing a budget for the DEM activities, it is important to incorporate the DEM activities into an Annual Performance Plan (APP) and an Operational Plan (OPP) for all departments. In October/November each year, costing of the OPP is discussed, and this will be the appropriate time to secure a budget for the DEM activities.

For municipalities, officials are encouraged to secure a budget for the DEM activities in their Integrated Development Plan (IDP) and the Services Delivery Budget Implementation Plan (SDBIP). The SDBIP is constituted around February or March each year since the financial period of the municipality will start in July of that year.

Provincial and district DSDs utilise a sub-programme's budget, such as 'Services to Persons with disabilities', 'Disability mainstreaming', 'Special programme unit', or Community Development budgets for the DEM activities.

Some disability coordinators are good at negotiating to bring budgets from other units (e.g. Children, HIV/AIDS, etc.) to conduct the DEM activities for the promotion of disability mainstreaming in specific units.



## WISDOM FROM PARTICIPANTS: Efforts to overcome challenges to implementing the DEM activities

“DSD has a responsibility for preparing venues, transport, catering and other necessary items to implement the DEM activities. DSD sometimes face challenges such as: 1) to secure funding due to limitation of the department's budget; 2) to arrange accessible transport, venue and accommodation for persons with disabilities; 3) to allocate the government vehicle for officials to implement the project; 4) to get hold of other relevant stakeholders due to their unavailability, and so on. To overcome these challenges, DSD cooperates with various stakeholders including municipalities. When we conducted Peer Counsellor Training, the municipality shared the responsibility and covered a part of the costs for catering, venue and accommodation.

In addition, the department tries to integrate the DEM activities into existing programmes. DSD Eastern Cape plans to integrate the DEM activities into the Non-profit organisation (NPO) funding system. For instance, peer counselling and disability awareness activity may be included into activities of NPOs which are receiving the NPO funding.

The DEM activities should be sustained even though there are some challenges. DSD should keep promoting the empowerment of persons with disabilities and disability mainstreaming as the lead department in providing social development services for persons with disabilities.”

– *Nosipho Sishuba, disability coordinator, DSD Eastern Cape province*





A team consisting of persons with disabilities and government officials assess accessibility at a SASSA office (Free State)



## PART 5



Persons with disabilities measure the gradient of ramp at a municipal office (Free State)

## GOOD PRACTICE CASE STUDIES



## DISABILITY MAINSTREAMING IN DIFFERENT DIRECTORATES IN DSD

---

### Disability mainstreaming in Chief Directorate of Children's Services

In the Children's Act (Act No. 38 of 2005), the General Principles state: "All proceedings, actions or decisions in a matter concerning a child must recognise a child's disability and create an enabling environment to respond to the special needs that the child has."



Furthermore, Section 11 in the Children's Act highlights that in any matter concerning a child with disability, due consideration must be given to the following:

- a) Providing the child with parental care, family care or special care as and when appropriate
- b) Making it possible for the child to participate in social, cultural, religious and educational activities, recognising the special needs that the child may have
- c) Providing the child with conditions that ensure dignity, promote self-reliance and facilitate active participation in the community
- d) Providing the child and the child's caregiver with the necessary support services.

In line with the Children's Act, the Chief Directorate of Children's Services of national DSD is accelerating disability mainstreaming in children's services in collaboration with the Directorate of Services to Persons with Disabilities. The process of their cooperation is as follows:

- June 2019: Chief Directorate of Children's Services invited officials of the Directorate of Services to Persons with Disabilities to the quarterly meeting for provincial children's coordinators in order to sensitise them on disability mainstreaming. This invitation aimed to recognise the importance of disability mainstreaming in children's services at provincial level. The participants were impressed by the session and exchanged ideas on how to promote disability mainstreaming in their daily tasks.
- August 2019: Chief Directorate of Children's Services in collaboration with the Directorate of Services to Persons with Disabilities conducted a knowledge-sharing meeting for all officials of the Chief Directorate of Children's Services. The participants came to understand disability mainstreaming by sharing information on the legislative framework, the social model of disability, the DEM approach, as well as the Disability Mainstreaming Implementation Toolkit.
- October 2019: Free State provincial DSD in collaboration with national and district DSDs organised a session on Disability Mainstreaming Training in the Child and Youth Care Centre (CYCC) at Leratong. Social workers, caregivers and other relevant stakeholders participated in the training and acquired knowledge on how to take action towards disability mainstreaming in the CYCC. They developed action plans to implement activities for disability mainstreaming such as: 1) Conduct awareness campaigns for promoting rights of children with disabilities; 2) Provide training for government officials and stakeholders; 3) Form a task team to organise all activities to promote empowerment of persons with disabilities and disability mainstreaming.

An example of a training programme is as follows:

<b>DAY</b> 	<b>TIME</b> 	<b>ITEM</b> 
<b>DAY 1</b>	09:00–09:30	Welcome and introductions
	09:30–10:00	Purpose and background
	10:00–11:00	What is disability? <ul style="list-style-type: none"> <li>• Understanding the social model of disability</li> </ul>
	11:00–13:00	Legislative framework <ul style="list-style-type: none"> <li>• WPRPD</li> <li>• Children’s Act</li> <li>• Legislation of CYCC</li> </ul>
	13:00–14:00	Lunch break
	14:00–15:30	How to mainstream disability <ul style="list-style-type: none"> <li>• Disability Mainstreaming Implementation Toolkit</li> <li>• Reasonable accommodation for children with disabilities</li> </ul>
	15:30–16:00	Q & A
<b>DAY 2</b>	09:30–10:00	Recap of Day 1 of the workshop
	10:00–12:00	Access audit practice at CYCC
	12:00–13:00	Lunch break
	13:00–15:00	How to communicate, care and support children with disabilities <ul style="list-style-type: none"> <li>• Share experiences, by parents of children with disabilities, caregivers and relevant stakeholders</li> </ul>
	15:00–16:00	Q & A
<b>DAY 3</b>	09:30–10:00	Recap of Day 2 of the workshop
	10:00–12:00	Development of an activity plan
	12:00–12:30	Presentation on activity plan
	12:30–13:00	Q & A
	13:00–	Way forward and closing

## Disability mainstreaming in Directorate of HIV/AIDS Services

The United Nations (UN) recognises that the relationship between HIV/AIDS and disability is a cause for concern as persons with disabilities are often at higher risk of exposure to HIV. The UN also emphasises that there is a growing understanding that persons living with HIV or AIDS are also at risk of becoming disabled on a permanent or episodic basis as a result of their condition.

In November 2019, the Directorate of HIV/AIDS in collaboration with the Directorate of Services to Persons with Disabilities conducted a knowledge-sharing meeting on disability mainstreaming for all officials of the Directorate of HIV/AIDS. The participants recognised the importance of disability mainstreaming in the HIV/AIDS sector in their understanding of the WPRPD and the DEM approach.

They also exchanged information about the challenges of promoting disability mainstreaming in the HIV/AIDS sector. For instance, some medical staff and local officials lack respect for the rights of persons with disabilities, and persons with communication difficulties have problems with inaccessible information on HIV/AIDS.

As a result of the meeting, the Directorate of HIV/AIDS plans to sensitise provincial HIV/AIDS coordinators to disability mainstreaming in the upcoming provincial coordinators meeting in 2020.



Disability mainstreaming training is conducted in the CYCC in collaboration with the children's unit (Free State)

## DISABILITY MAINSTREAMING IN DIFFERENT DEPARTMENTS AND SECTORS

---

### Education and health sector

Census 2011 data on the number of persons with disabilities attending education institutions reveals that this marginalised sector continues to experience difficulty in accessing this very important right. For instance, about 35.5% of children with severe difficulty in walking do not attend school. Inclusive education should be accelerated by promoting disability mainstreaming and empowerment of children with disabilities. The outcome of disability mainstreaming can bring positive impacts not only for children with disabilities but also for children without disabilities. For instance, inclusive education develops mutual learning and understanding among children with and without disabilities. This enables the creation of mutual assistance in a diverse and inclusive society. Also, teachers develop their skills to meet the needs of each child with and without disabilities, which contributes to better educational outcomes for all children in school.

Awareness-raising activities and access audits at schools are shown here as examples of good practices in collaborating with the education and health sector.

#### **1** Hlalukweni High School in Collins Chabane municipality, Vhembe district, Limpopo province

In August 2019, the principal of Hlalukweni High School invited the DEM working group to conduct disability awareness activities and an access audit at the school. As background to the activity, a wheelchair user of the working group visited the school to take an exam privately, and he struggled with the poor accessibility of the school facilities. The school principal acknowledged the importance of accessibility through this experience, although there are no learners using a wheelchair currently at the school.

Through the disability awareness activity, about 100 learners and teachers enjoyed dialogue with six working group members with disabilities and came to understand disability based on the social model perspective, as well as how to address disability. These learners are expected to contribute to creating an inclusive society in the future.

The DEM working group, teachers and learners conducted an access audit after the disability awareness activity. They checked the accessibility of school facilities, especially the entrance, toilets, classrooms and parking, and recommended installing ramps and accessible toilets. The school principal is currently discussing with local municipalities how to improve the school's accessibility based on the results of access audit.

## **2** Hasani Lawrence senior primary school in Collins Chabane municipality, Vhembe district, Limpopo province

The working group members of DEM activities conducted an access audit at Hasani Lawrence senior primary school.

A boy using a wheelchair, aged 10, is going into Grade 5 in 2020 at the senior primary school. In preparation for his enrolment, the Office of the Premier asked the occupational therapy (OT) section of Malamulele hospital to conduct an access audit at the school and his house. After that, the OT section consulted the DEM working group to assist in an access audit since the OT had participated in Access Auditor Training conducted by the DEM project.

The access audit team consisting of the DEM working group, school principal, OT and the community forum conducted the access audits and found several challenges such as toilets, ramps and handrails. The access audit team submitted a recommendation report for improving accessibility, to relevant stakeholders.

As a result of the access audit, a ramp was installed at the boy's home supported by the community forum. The boy said: "I can move freely without any assistance in my house now. I am very happy to go to school every day."

### **Public Works**

The Department of Public Works and Infrastructure (DPW) is committed to the attainment of a transformed built environment sector, including establishing and ensuring compliance with policy and legislative prescripts for the construction and property sectors, and contributing to the national goals of job creation and poverty alleviation through public works programmes.

## **1** Thabo Mofutsanyana district DPW, Free State province

Thabo Mofutsanyana district DPW in Free State province is actively involved in an access audit with the DEM working group. A chief of artisans in the district DPW advised as an expert in construction when the DEM working group conducted its access audit at public buildings. The chief of artisans also learned from members with disabilities through listening to their ideas as users of facilities and services. As an outcome of the series of cooperation activities, district DPW built two accessible community halls including wheelchair-accessible toilets and ramps in compliance with Part S of the South African National Standards (SANS) 10400, at Mbeki community hall and Lusaka community hall.

## **2** Public Works programme in communities

DPW has a responsibility for the Expanded Public Works Programme (EPWP), which provides poverty and income relief through temporary work for the unemployed to carry out socially useful activities. The EPWP has been established to create work opportunities across four sectors: Infrastructure, Non-State, Environment and Culture, and Social. The DEM working group approaches these Public Works programmes so that persons with disabilities can participate in the programmes on an equal basis with others. The following section shows how the working group approached such public programmes to increase the participation of persons with disabilities in those programmes in collaboration with municipalities.



## COLLABORATION WITH MUNICIPALITIES

As described in Part 3, district and local municipalities play an important role in implementing the DEM approach at district and local municipality levels. There are three main reasons why municipalities have important roles:

- The municipalities have their own responsibility and budgets for the promotion of disability mainstreaming as a cross-cutting issue
- The municipalities including councillors work closely with communities to provide public services at community level
- The municipalities organise a Disability Forum, which consists of persons with disabilities at the local level to discuss disability issues in their communities.

District and local municipalities in the implementation sites of the DEM project participate with a strong commitment, and a number of outcomes have emerged, as follows:

- Some district and local municipalities contributed to funding the DEM activities such as catering and transport for capacity building training.
- Local ward councillors in collaboration with the DEM working group worked together to increase the participation of persons with disabilities in public works programmes such as EPWP and CWP. For instance, the working group provided information to the local ward councillors on persons with disabilities who have potential to participate in the public works programmes. After this, the local ward councillors connected the public works programme with these persons with disabilities. These actions contributed to the economic empowerment of persons with disabilities.

The involvement of the Disability Forum of the local municipality with the DEM working group, as shown here, is an example of good practice.



Working group consisting of Disability Forum members, government officials and NGO staff meet to discuss plans (KZN)

### Disability Forum of Mandeni municipality, iLembe district, KwaZulu-Natal province

The provincial and district DSDs selected Mandeni municipality as the implementation site and involved the Disability Forum in the DEM activities because they have a strong commitment to addressing disability issues and holding meetings regularly. The working group's meetings are conducted monthly on the same day as the Disability Forum's meetings. This strategy is an efficient way to save costs and time, and contributes to the overall sustainability of the DEM working group's activities.

Furthermore, the Disability Forum had wanted to address a problem of accessibility at the SASSA office in Mandeni municipality for a long time, but they could not solve the issue. However, through the DEM project, they developed an activity plan with DSD officials to improve the accessibility of the SASSA office. Finally, they succeeded in conducting an access audit to improve SASSA office facilities in collaboration with the SASSA office manager. After the DEM working group submitted their recommendation report which mentioned the results of access audit, the manager invited the working group to offer suggestions on accessibility when a new SASSA office design is created in the near future.



#### WISDOM FROM PARTICIPANTS: Impact of the DEM approach

“I have been involved with the Disability Forum of Mandeni municipality since the forum was established in 2006. The forum became active little by little, and nowadays holds a monthly meeting. In the meetings, government officials used to provide some information and advice on disability, and persons with disabilities usually listened to their advice. However, after the DEM project was commenced, government officials got to listen to the voices of persons with disabilities and asked for our inputs.”

– *Musawenkosi Skhakhane, chairperson: Disability Forum of Mandeni municipality*

“Communication ways between government officials and persons with disabilities have changed and their relationship became much better. Before the commencement of the DEM project, persons with disabilities made request about their needs and government officials then answered about their requests. This means they communicated at different levels, not as equals. Now, we discuss together how to address disability issues without any conflicting levels or position.”

– *Bukiwe Gwele, social work supervisor: DSD KwaZulu-Natal province*

“The DEM project is simple, easily understandable and practical in comparison with other disability programmes. The roles of government officials are not just about providing funding, but also about listening to the voices of persons with disabilities and taking action based on their needs. The officials got to think and work with persons with disabilities together in order to solve disability issues.”

– *Zama Nzimande, special needs coordinator for iLembe district*



## PART 6



Persons with disabilities listen to and share their challenges and needs in peer counselling session (Limpopo)

## CONCLUSION

The Department of Social Development (DSD) and the Japan International Cooperation Agency (JICA) developed the DEM approach to achieve the empowerment of persons with disabilities and disability mainstreaming at district and local level. They have used the ongoing experiences of a four-year technical cooperation project to take the programme forward at each stage. Key elements of the DEM approach are highlighted as follows:

- Persons with disabilities and their families should be first and centre in all processes and activities
- It is a principle to capacitate and empower persons with disabilities first to enable their active participation in the activities (e.g. by conducting peer counselling for the empowerment of persons with disabilities)
- Another principle is to establish a working group composed of persons with disabilities, governments, municipalities and other key stakeholders so that they work together equally as a team
- The working group develops an activity plan to address barriers to participation of persons with disabilities in the implementation site, based on the results of a baseline survey
- Activities are implemented in the community at local municipality level in collaboration with national, provincial and district governments.

By way of conclusion, the definition of the DEM approach is reiterated: it is a way to empower persons with disabilities and create a platform for persons with disabilities, governments, municipalities and other key stakeholders, in order to realise the participation of persons with disabilities in the implementation of disability mainstreaming at district and local level.

The guidelines documents are circulated to the DSD provincial offices, national departments, disability organisations, and other stakeholders. The guidelines serve to guide future projects nationally in the implementation of the DEM approach, to ensure that all persons with disabilities enjoy equal rights, and to create an inclusive community.



### WISDOM FROM PARTICIPANTS: Roll-out of the DEM approach

“The DEM approach can be applied in any social development programme. National DSD plans to apply the DEM approach to the Respite Care programme.

The Respite Care programme is one of the priorities for DSD from 2020 to 2024, focusing on children, adults with disabilities, and their families. From 2020, DSD will implement a pilot project for the Respite Care programme, incorporating the DEM approach. Based on the results of the pilot project, DSD will revise the guidelines for its own Respite Care programme and roll out the Respite Care programme in all provinces.”

– *Manthipi Molamu, director: Directorate of Services to Persons with Disabilities, National DSD*

# BIBLIOGRAPHY

- Cooperative Governance & Traditional Affairs. <http://www.cogta.gov.za/>
- Department of Public Works and Infrastructure. Expanded Public Works Programme. <http://www.epwp.gov.za/>
- Department of Social Development, RSA. 2012. Disability Mainstreaming Implementation Toolkit.
- Department of Social Development, RSA. 2019. Policy on Social Development Services to Persons with Disabilities (final draft).
- Department of Social Development, RSA. 2015. White Paper on the Rights of Persons with Disabilities. <https://www.gov.za/documents/white-paper-rights-persons-disabilities-official-publication-and-gazetting-white-paper>
- Disability Equality Training (DET) Forum. [http://www.detforum.com/DET Training Video](http://www.detforum.com/DET%20Training%20Video). 2011. <https://www.youtube.com/watch?v=IBlfzALO7p0>  
<https://www.youtube.com/watch?v=hpLrk03PCbY>
- Human Care Association, Japan. 2015. Peer counsellor guidelines.
- Japan International Cooperation Agency (JICA). 2015. JICA Thematic Guidelines: Disability and Development. [https://www.jica.go.jp/english/our\\_work/thematic\\_issues/social/activity.html](https://www.jica.go.jp/english/our_work/thematic_issues/social/activity.html)
- Kuno, K. 2012. *Doing Disability Equality Training: A handbook for trainers*. Kuala Lumpur: MPH Publishing. (Disability equality training [DET] manual no. 6). <http://detforum.com/intl/wp-content/uploads/2009/03/Doing-Disability-Equality-Training.pdf>
- Miyairi, K. & Yokoo, Y. 2007. *Book of Universal Design*. Japan: Nikkan Kogyo Shimbun Ltd.
- QuadPara Association South Africa (QASA). n.d. Sawubona Disability. <https://qasa.co.za/sawubona-disability/>
- Statistics South Africa (Stats SA). Census 2011. [http://www.statssa.gov.za/?page\\_id=3839](http://www.statssa.gov.za/?page_id=3839)
- South African Bureau of Standards (SABS). 2011. South Africa National Standards (SANS) 10400-S. <https://www.sabs.co.za/Sectors-and-Services/Services/Access/accesssp.asp>
- South African Government. Children's Act 38 of 2005. <https://www.gov.za/documents/childrens-act>
- South African Government. Government system. <https://www.gov.za/about-government/government-system>
- South African Local Government Association (SALGA). <https://www.salga.org.za/>
- Tokyo Metropolitan Government. 2020. The design manual of the accessibility code of the Tokyo Metropolitan Government. <https://www.fukushihoken.metro.tokyo.lg.jp/kiban/machizukuri/manual.html>
- United Nations. 2006. Convention on the Rights of Persons with Disabilities (CRPD). <https://www.un.org/development/desa/disabilities/convention-on-the-rights-of-persons-with-disabilities.html>
- United Nations. Department of Economic and Social Affairs. Disability and HIV/AIDS <https://www.un.org/development/desa/disabilities/issues/disability-and-hivaids.html>
- United Nations. Department of Economic and Social Affairs. Sustainable Development Goals (SDGs) and Disability. <https://www.un.org/development/desa/disabilities/about-us/sustainable-development-goals-sdgs-and-disability.html>
- World Bank. Disability inclusion. <https://www.worldbank.org/en/topic/disability>
- World Health Organization (WHO). 2010. Community-based rehabilitation: CBR guidelines. <https://apps.who.int/iris/handle/10665/44405>





Persons with disabilities develop materials for practice in conducting a disability awareness activity (Eastern Cape)

# TOOLS



A working group discusses how to consolidate the developed activity plan (KZN)



## TOOL 1

# EXAMPLE OF TERMS OF REFERENCE OF WORKING GROUP FOR IMPLEMENTING THE DEM APPROACH

### 1 OBJECTIVES AND FUNCTIONS OF WORKING GROUP

---

- To develop an activity plan and implement the planned activities for the empowerment of persons with disabilities and disability mainstreaming (DEM) in the implementation site
- To discuss technical and practical matters concerning activity implementation
- To review the achievements of the activity plan, and report to district DSD, district municipality and other key stakeholders
- To discuss solutions to major issues arising from or in connection with the activity implementation, and to respond with appropriate measures
- To discuss any other issues relevant to the smooth implementation of the planned activities.

### 2 ROLES OF CHAIRPERSON

---

The chairperson is elected by the working group. The roles and responsibilities of the chairperson are as follows:

- To manage the day-to-day activities of the working group
- To chair working group meetings and facilitate the activities of the working group
- To share information concerning activities within the working group
- To finalise minutes of meetings and report it to district DSD, district municipality and other key stakeholders.

The vice chairperson takes over responsibility as acting chairperson in the event that the chairperson requests it, with reasonable reasons.

### 3 ROLES OF SUPERVISOR

---

A provincial government official is in charge of the supervisor. The recommended supervisor is a provincial disability coordinator from provincial DSD. The roles and responsibilities of the supervisor are as follows:

- The supervisor advises and coordinates the working group members on the implementation of the planned activities
- Disputes or disagreements between working group members that arise in relation to the DEM activities should be referred to the supervisor by any member for resolution. The supervisor coordinates and provides advice to resolve these disputes.

## 4 MEMBERS

ROLE IN THE WORKING GROUP	NAME	POSITION/ ORGANISATION
Chairperson		e.g. Representative of persons with disabilities
Vice chairperson		
Secretary		
Supervisor		e.g. Provincial disability coordinator



The members may change if the need arises.





## TOOL 2

# FACILITATION GUIDE ON PEER COUNSELLOR TRAINING

### 1 BACKGROUND

---

Peer counselling is a strong and effective tool for empowerment of persons with disabilities. 'Peer' means a person who is of equal standing to another person, and has a similar background. Persons with disabilities listen and speak to the challenges and needs of one another.

Through peer counselling, persons with disabilities heal the pain from various social disadvantages so that they can recover self-reliance and rebuild human relationships. Peer counselling aims at empowering persons with disabilities to be independent, become part of community and participate in any and all social activities. Their empowerment both works to change the society and remove social disadvantages ultimately.

### 2 OBJECTIVES OF THE TRAINING

---

- To deepen understanding on the topics of peer counselling (e.g. nature of human beings, discharge of emotion, etc.)
- To learn how to conduct and facilitate peer counselling through practice.

### 3 TARGET PARTICIPANTS

---

- Potential leaders with disabilities in the implementation site
- The number of participants is recommended to be fewer than 15 persons per facilitator for well-managed training and for achieving the objectives.
- Since this is peer-to-peer support, **only persons with disabilities are able to participate.**
- **On the last day** of the training, **stakeholders such as government officials can participate** in the programme (see Day 4 of the following programme example).

## 4 RECOMMENDED ORGANISERS AND DEMARCATION

The organisers are drawn from district DSD and municipalities in collaboration with provincial DSD and the working group. The recommended demarcation is as follows:

- a) District DSD and municipalities in collaboration with provincial DSD and the working group
  - Nomination of participants with disabilities
  - Arrangement of accessible venue, transport for participants, and catering
  - Communication and coordination with peer counsellor
  - Dispatch of trainer(s) (in consultation with national DSD if need arises)
- b) Trainer(s)
  - Development of programme and materials
  - Facilitation of the training
  - Development and submission of report on the training to the organisers





## 5 PROGRAMME EXAMPLE

The length of training should be three or four days to achieve the training purposes.

An example of a four-day programme is as follows:

DAY 	TIME 	PROGRAMME 
DAY 1	09h30 – 09h45	Welcome and introductions
	09h45 – 10h00	Purpose of Peer Counsellor Training
	10h00 – 10h30	What is peer counselling?
	10h30 – 11h00	Relation building
	11h00 – 11h45	Peer counselling 1
	11h45 – 12h15	New and good
	12h15 – 13h15	Lunch
	13h15 – 14h15	Peer counselling 2
	14h15 – 15h15	Discharge of emotion
	15h15 – 15h30	Q & A

DAY 	TIME 	PROGRAMME 
<b>DAY 2</b>	09h30 – 10h00	Recap of Day 1 of the training
	10h00 – 11h00	Disability
	11h00 – 12h00	Nature of human beings
	12h00 – 12h45	Appreciation
	12h45 – 13h45	Lunch
	13h45 – 14h30	Good and learn
	14h30 – 15h15	Practice of peer counselling
	15h15 – 15h30	Q & A
<b>DAY 3</b>	09h30 – 10h00	Recap of Day 2 of the training
	10h00 – 12h30	Practice of peer counselling in community
	12h30 – 13h30	Lunch
	13h30 – 15h00	Practice of peer counselling in community
	15h00 – 15h15	Feedback from trainer
	15h15 – 15h30	Q & A
<b>DAY 4</b>	09h30 – 10h00	Brief explanation of peer counselling to government officials by participants
	10h00 – 12h00	Development of peer counselling activity plan
	12h00 – 12h30	Presentation of activity plan
	12h30 – 12h45	Evaluation of Peer Counsellor Training
	12h45 – 13h00	Way forward
	13h00 – 14h00	Lunch

## 6 TRAINING CONTENT

Peer counselling is a strong method for empowerment of persons with disabilities. Essentially, peer counselling for persons with disabilities should only be conducted for and by persons with disabilities because this is peer-to-peer support.

The training contains three main components: 1) Overview of peer counselling (Day 1–2); 2) Practice of peer counselling in community (Day 3); and 3) Brief explanation of peer counselling to stakeholders (Day 4).



### 6.1 Overview of peer counselling (DAYS 1–2)

The participants learn the objective, rules, how to facilitate peer counselling and important topics of peer counselling by trainers. The main topics to be explained and discussed are as follows:

- Peer counselling 1
- Peer counselling 2
- Discharge of emotion
- Disability
- Nature of human beings
- Appreciation, etc.

In the training, participants practise how to facilitate peer counselling – both group peer counselling and one-to-one peer counselling.

### 6.2 Practice of peer counselling in community (DAY 3)

The participants visit a village to conduct peer counselling for persons with disabilities in the community. This is a practice session for the participants.

The organiser should obtain the approval of key stakeholders such as community leaders before the practice of peer counselling in the community.

### 6.3 Brief explanation of peer counselling to stakeholders by participants (DAY 4)

This explanation aims to promote understanding and support from persons without disabilities, especially officials of DSD, district and local municipalities, and other stakeholders, for the long-term sustainability of peer counselling. The training participants explain what they have learned as well as giving an overview of peer counselling by referring to Tool 3: Presentation on Peer Counsellor Training, as follows:

### 6.3.1 What is peer counselling?

Peer counselling is the mutual support of persons with disabilities through sharing and listening. This is the short definition of peer counselling. The key point is that peer counselling is **mutual support** of persons with disabilities (not a provider and recipient relationship but an equal one). The method of peer counselling is sharing and listening.

### 6.3.2 Objective of peer counselling

The objective is to empower persons with disabilities. Through peer counselling, persons with disabilities heal the pains from various social disadvantages, recover self-reliance and rebuild human relationships.

### 6.3.3 Why peer counselling is important

Peer counselling is very important for persons with disabilities because it is where persons with disabilities gain their voice and sense of belonging. Peer counselling enables persons with disabilities to raise their voices freely and provides a place where they can feel at ease with friends and colleagues with a similar background.

### 6.3.4 Why only for persons with disabilities?

Since 'peer' means colleagues or persons who have a similar background, peer counselling is only for persons with disabilities: this is where they can share knowledge, experiences, challenges, and give emotional, social and practical support to one other on an equal basis.

### 6.3.5 Rules of peer counselling

- Divide time equally: Each participant is allocated the same amount of time, and they are free to use all their own time in the way they choose.
- Confidentiality: Do not talk with others about what the participants tell you in peer counselling.
- No denial, no criticism: Do not contradict or talk over participants when they speak their mind. Accept and receive their emotions.
- Do not give advice: We avoid giving advice because we don't want to take away anyone's ability to solve their own problems.

These are the basic rules for peer counselling. In addition, there might be a recommended rule that there be no smoking, no drinking alcohol or caffeine beverages during peer counselling.

### 6.3.6 Good practice of peer counselling at the site

A government official introduces good practice in peer counselling as an outcome of the collaboration between government officials and peer counsellors. For instance, the case of Limpopo province is shared as follows:

Peer Counsellor Training was conducted and 15 persons with disabilities were capacitated.  
Trained persons with disabilities conducted peer counselling in more than 20 villages.

Not only provincial and district DSD, but also municipalities assisted in arranging transport, venue and catering (when necessary).

*Note: It is recommended that this slide is explained by a government official in order to share the experience of positive collaboration between government and persons with disabilities.*

### 6.3.7 Expected roles of government and stakeholders

Peer counselling can be used to implement the White Paper on the Rights of Persons with Disabilities (WPRPD), especially Pillar 4 for promoting and supporting the empowerment of persons with disabilities.

In Limpopo, the provincial and district DSD secured the budget for peer counselling and conducted peer counselling. The activity was well received by senior management including the Head of Department (HOD) and Director.

*Note: This slide should be presented by a DSD official in order to get buy-in from government officials.*

## 7 AFTER THE TRAINING: PEER COUNSELLING BY TRAINED PERSONS WITH DISABILITIES

Trained persons with disabilities conduct peer counselling to promote the empowerment of persons with disabilities as well as improve their skills through practical activities. At least two trained peer counsellors facilitating peer counselling together is recommended so that they can assist each other.

The target participants are persons with disabilities in the community. It is recommended that the number of participants be fewer than 15 persons per peer counsellor for well-managed training and for achieving the objective. The length and content of the peer counselling session should be discussed and decided by the trained peer counsellor, DSD officials and community stakeholders. A minimum of 2–3 hours is needed, and training (or parts of the training) might be conducted several times if the need arises.



## 7.1 Expected organisers and demarcation

The organisers are district DSD and municipalities in collaboration with the working group. The recommended demarcation is as follows:

- a) District DSD and municipalities in collaboration with the working group
  - Nomination of participants with disabilities from community (through ward councillor, chief or traditional leader in the community)
  - Arrangement of accessible venues, transport for participants, and catering
  - Communication and coordination with trained peer counsellors.
- b) Trained peer counsellors
  - Development of programme and materials
  - Facilitation of peer counselling
  - Share of the outcomes of peer counselling with the organisers

## 7.2 Programme example (One-day peer counselling)

TIME 	PROGRAMME 
10h00 – 10h20	Welcome and introductions
10h20 – 10h30	Purpose of peer counselling
10h30 – 10h50	What is peer counselling?
10h50 – 11h20	Relation building
11h20 – 11h40	New and good
11h40 – 12h10	Nature of human beings
12h10 – 12h40	Discharge of emotion
12h40 – 13h30	Lunch
13h30 – 14h05	Peer counselling 1
14h05 – 14h35	Disability
14h35 – 15h05	Appreciation
15h05 – 15h25	Good and learn
15h25 – 15h30	Way forward and closing





## REFERENCES

This material and the content of the Peer Counsellor Training was designed based on the peer counsellor guidelines developed by the Human Care Association (Japan) and revised by Mr July Mathebula, peer counsellor.



Peer counselling is conducted for/by persons with disabilities in a village (Limpopo)



TOOL 3

# Presentation on Peer Counsellor Training - Overview of peer counselling -

Building a Caring Society. Together.

[www.dsd.gov.za](http://www.dsd.gov.za)



This material and the content of the Peer Counsellor Training were designed based on the peer counsellor guidelines developed by the Human Care Association (Japan) and revised by Mr July Mathebula, peer counsellor.



## What is peer counselling?

Peer counselling is the **mutual support** of persons with disabilities through **sharing and listening**.



2



# Objective of peer counselling

The objective is to **empower** persons with disabilities. Through peer counselling, persons with disabilities heal the pain from social disadvantage, recover self-reliance and rebuild human relationships.



3



## Why peer counselling is important?

Peer counselling is very important for persons with disabilities since it is where persons with disabilities **gain their voices and a sense of belonging.**



4

## Why only for persons with disabilities?

**‘Peer’ means a colleague or person who has a similar background.**

**Peer counselling is only for persons with disabilities where they can share knowledge, experiences, challenges, and emotionally, socially and practically support one another in an equal manner.**

5

## Rules of peer counselling

- **Divide time equally:** Each participant is allocated equal time, and they are free to use all own time in the way they choose.
- **Confidentiality:** Do not talk with others about what the participants tell you in peer counselling.
- **No denial, no criticism:** Do not contradict the participants when they speak their mind. Accept and respect their emotions.
- **Do not give advice:** We avoid giving advice because we don't want to take away the ability of people to solve their own problems.

6



## Good practice of peer counselling in Limpopo

- Peer Counsellor Training was conducted and 15 persons with disabilities were capacitated.
- Trained persons with disabilities conducted peer counselling in more than 20 villages.
- Not only provincial and district DSD but also district and local municipalities assisted in arranging transport, venues and catering (when necessary).

7



## Expected roles of governments and stakeholders

- Peer counselling can be used to **implement the White Paper on the Rights of Persons with Disabilities (WPRPD)**, especially Pillar 4 for promoting and supporting the empowerment of persons with disabilities.
- In Limpopo, the provincial and district DSD **secured a budget** for peer counselling and conducted peer counselling.
- The activity was well received by senior management including HOD and Director.

8



## TOOL 4

### MATERIALS ON PEER COUNSELLOR TRAINING

#### 1 RELATION BUILDING

Form a circle and ask each participant to introduce themselves.

Participants should give their full name, the name they want to be called by, where they come from, their hobbies and interests, what they want to be understood about their impairment/disability. (2 minutes per person [p/p])

In pairs, introduce each other. After this, make a circle again, and then introduce your partner to others.

(30 minutes)



#### DO I KNOW YOU?

Relation building is ice-breaking for participants in that it is an opportunity for strangers to get to know one another. If you are conducting peer counselling with the same participants, you may be able to skip relation building. When you have a new member, however, it would be good to do relation building.

#### 2 NEW AND GOOD

New and good is done at the beginning of the course.

Despite the negative challenges in our own lives, we also have new good things happening in our lives (e.g. when my uncle bought me a pair of sneakers, it was a new thing, and a good thing is that today the sun is shining).

The facilitator tells participants about the timeframe.

Before you start the new and good session, you will set a time period (perhaps in the last week; or say, specific dates, from 1 June to 10 June).

Then ask the participants if they need time to think about what is new and good in their lives (1 minute).

Next, start new and good one by one (1 minute p/p).

(20 minutes)



## 3 PEER COUNSELLING 1

### 3.1 Purpose of peer counselling

The goal is for persons with disabilities to achieve living independently through peer counselling. We heal the pains from various social disadvantages, so that we can recover our self-reliance and rebuild our human relationships. 'Peer' means colleague or one who is on equal standing with another.

There are three objectives in peer counselling:

**3.1.1 Recovery of self-reliance:** We recognise what prevents us from realising our wants and needs (disability) and then we will be able to fully express our feelings in peer counselling (discharge of emotions). After full expression of our feelings, we re-evaluate ourselves (i.e. to regain our self-esteem).

**3.1.2 Rebuilding of human relationships:** We want to rebuild relations between ourselves as disabled persons and society in the community. To renew our self-image, we build an active relationship with the peer counsellor first; then we can eventually reconstruct relationships with other people. We need to be on the same ground as the other person (e.g. get out and make new friends).

**3.1.3 Social change:** We as persons with disabilities can go out in the community and change the way of thinking of other people in society. We need to prove to people that being friendly towards and supporting persons with disabilities is important for all human beings. In order to change how the community thinks of us, persons with disabilities need to come together and be with persons without disabilities (e.g. we need to go out as a group to make people aware that persons with disabilities need accessibility to move around).



#### TOPIC:

Choose one topic from the three objectives.



#### SESSION:

3–5 minutes p/p  
(45 minutes)

#### (TENSION BACK)



#### THINK AND LISTEN:

(explain first what this is)  
(1 minute p/p)



## THE TERMS USED IN PEER COUNSELLING

**Counsellor:** In general counselling, counsellors are persons who have received specific training for counselling work. However, in sessions of peer counselling, counsellors are in the role of persons who listen to clients attentively and assist clients' discharge of emotions.

**Client:** In general counselling, a person who receives specialised psychotherapy or counselling is called a client. In peer counselling, however, a client is the role of persons who speak about what they feel and think on various issues, including issues about their disabilities, living conditions and social welfare. Participants of peer counselling rotate their roles between counsellor and client in a session – participants who take the role of counsellor first would play the role of client next.

**Tension back:** When a client is deeply involved in their story, it is often the case that even when the counselling is over (after the story is over), the client is unable to get out of the world of the story. In such a case, a method is used in which a counsellor throws a completely different topic at the client. For example, "What are you making for this evening's meal?" or "What three countries begin with A?" The client returns to his/her normal self while answering the counsellor's questions. This is a method to return the state of the mind of the client to some sort of normal or original state.

**Think and listen:** Three or more people share time with one another and listen to the other's opinions based on a theme. In doing so, the listener is dedicated to listening to the speaker's story and does not enter into any questions, disputes, opinions, or refutation, and instead accepts the speaker's story.

## 3.2 Rules of peer counselling

- Equal allocation of time among participants
- Confidentiality
- No denial, no criticism
- Don't give advice

Possible additional basic rules: no smoking, no alcohol, and perhaps no caffeine.

Explain the rules of peer counselling.

**3.2.1 Divide time equally:** Be aware that the time is totally yours and share it equally between you.

**3.2.2 Confidentiality:** What your client tells you should stay with you. Do not talk with others about anything that is said or happens in peer counselling.

**3.2.3 No denial, no criticism:** We don't ever contradict the client or deny their time to speak their mind; we accept and receive the client's emotions.

**3.2.4 Don't give advice:** We avoid giving advice because we don't want to take away anyone's ability to solve their own problems.



### TOPIC:

Which of the rules would you like to talk about?



### SESSION:

3 minutes p/p

(TENSION BACK)



### THINK AND LISTEN:

(1 minute p/p)

## 4 PEER COUNSELLING 2

### 4.1 Role of the counsellor

**4.1.1 Listen attentively:** Be there for your participants emotionally and physically, and listen to your participants from the heart. Many persons with disabilities have little opportunity to be fully listened to by other people. Peer counselling with attentive listening better enables persons with disabilities to think about improving their own situation.

**4.1.2 Trust your client:** Trust clients 100 per cent. There are no right and wrong answers. Your participants can think, decide and determine their own thoughts and way of expressing themselves.

**4.1.3 Ask questions:** Assist clients to speak of their own feelings or their own mind. Ask questions to help them to speak their mind, and to show that you are interested in what they are saying (in other words, don't ask questions for own interest).

**4.1.4 Encourage clients to discharge their emotions:** Accept and receive clients' emotions by listening to all they say.

**4.1.5 Don't give advice:** We avoid giving advice because we don't want to take away clients' ability to solve their own problems.

**4.1.6 Don't get involved with your client's problems:** Try to avoid getting emotional and remember it's the client's time to talk, not the counsellor's time.

### 4.2 Role of the client

**4.2.1 Be aware the time is totally yours:** Use all your time freely and in any way you wish. Be aware too that the time and place is safe, your privacy is being protected by the counsellor.

**4.2.2 Stand back to recognise your problems:** Having problems does not mean there is something at fault with you because most can be solved.

**4.2.3 Discharge emotions freely:** By doing so, eventually you heal the wounds of the things that are on your mind.

#### TOPIC:

What is your expectation of this peer counselling session?

#### SESSION:

5 minutes p/p  
(30 minutes)

(TENSION BACK)

#### THINK AND LISTEN:

(1 minute p/p)



#### TOPIC:

Something you couldn't talk about to anybody

#### SESSION:

5 minutes p/p  
(30 minutes)

(TENSION BACK)

#### THINK AND LISTEN:

(1 minute p/p)

### 4.3 Reasons why peer counselling is conducted by persons with disabilities

**4.3.1 To be free from constraints:** Persons with disabilities feel more free to express themselves when they talk to other persons with disabilities.

**4.3.2 To be free from dependence:** There is no personal assistant or non-disabled person present. This helps you build confidence by seeing that you are not depending on anybody when you are in peer counselling.

**4.3.3 To understand that persons with disabilities can support one another:** By being there and helping one another.

## 5 DISCHARGE OF EMOTIONS

### 5.1 What comes to your mind when you hear the word 'emotion'?

Think and listen, one or two words each. (3 minutes total)

### 5.2 How do you express yourself when you feel sad?

Think and listen, one or two words each. (3 minutes total)



#### HOW DO I SAY HOW I FEEL?

There are many different types of emotion. There are many ways to express that emotion.

Emotion that happens in our mind can only come out or be expressed through our body.

In the wider community, however, it is not always easy for these kinds of emotions to be accepted. Society tends to prefer reason over emotion, containment over expression. However, humans are thinking and feeling beings and we can't live without emotions.

Why do we need to discharge our emotions?

By discharging emotions, we can heal the wounds of mind. When you feel sad, you can relieve pain in your mind by crying or speaking about your feelings of sadness with others. But if you can't do this, your pain of mind remains as a wound. And that wound of mind makes it difficult for you to move forward when you encounter a similar situation to the one that brought on your sadness. This is why we all need to learn how to discharge emotions.



#### (WARM UP) SAY:

Today we are going to talk about discharge of emotions.



#### TOPIC:

What you could not say even though you wanted to say it.



#### SESSION:

(5 minutes p/p)

(Don't forget to mention 'Tension back')



#### THINK AND LISTEN:

(1 minute p/p)



#### TOPIC:

When was your last joyous moment?



#### SESSION:

(3–5 minutes p/p, depending on time)



#### THINK AND LISTEN:

(1 minute p/p)



#### WRAP-UP:

Remind the participants about the topic, and maybe look at the explanation 'How do I say how I feel?' again.

## 6 NATURE OF HUMAN BEINGS

At residential facilities, clinics and hospitals, persons with disabilities are isolated and controlled. Even outside of these places, persons with disabilities are exposed to attitudes and words that undermine their confidence.

As a central premise of peer counselling, however, the nature of human being is considered as follows:

### 6.1 Human beings want to be loved and want to love:

Humans can't live alone because we need someone to love and, as human beings, we want to be loved (not only in the romantic sense, but in the sense of caring for someone and being cared for) by family, friends and other people we meet and interact with in life.

### 6.2 Human beings are full of intelligence:

Humans can choose and decide for themselves (this kind of intelligence is not about your results in an exam or your IQ score).

### 6.3 Human beings are full of creativity and talent:

Humans have the capacity to create something important (e.g. some people do mouth painting, modify their wheelchairs, play sports competitively).

### 6.4 Human beings are full of joy:

Persons with disabilities can have fun just like everyone else in the community. We have difficult experiences but we can still enjoy ourselves in our own way, such as going out, being with family and making friends.

### 6.5 Human beings are powerful:

Humans have the power to overcome difficult experiences (e.g. just being at peer counselling, a person feels more powerful).

#### (WARM UP) ASK:

What do you think about this word, human being? How do you think about it?

#### SESSION:

3 minutes p/p



#### TOPIC:

Which point about human beings impressed you most?

#### SESSION:

5 minutes p/p  
(talk about it in pairs)  
(30 minutes)

#### (TENSION BACK)

#### THINK AND LISTEN

#### WRAP-UP:

We are still human beings despite our disability, and we are capable of doing things the way we want to do them. Don't be afraid to mingle with non-disabled people because of your disability, go out and challenge the world.

## 7 DISABILITY

Persons with disabilities are used to thinking their impairment/disability is a negative thing. There are many reasons why you feel negative. There are different types of impairments/disabilities (e.g. para, quad, visual, hearing, albinism, etc.). Facing up to your problems and your impairment/disability makes it easier to think clearly.

Peer counselling looks into the following four points on impairment/disability:

### 7.1 For you, what is the meaning of impairment/disability?

### 7.2 For your family, what does it mean to have a person with a disability as a member?

(i.e. what is your relationship with your family?)

### 7.3 For the community, what is the meaning of impairment/disability?

(e.g. persons with disabilities are working together now to change the way of thinking of the community and trying to make things easier. What do you want to change in the community?)

### 7.4 What is the status of persons with disabilities in history?

(e.g. can you think of persons with disabilities who have become a success in life; or how things have improved for persons with disabilities because of changing attitudes, or technological developments?)

Leave people with a positive feeling.



#### TOPIC:

What do you think about your own impairment/disability?



#### SESSION:

5 minutes p/p



#### THINK AND LISTEN:

(circle) (1 minute p/p)



#### SESSION: 5 minutes p/p



#### THINK AND LISTEN



#### SESSION: 5 minutes p/p



#### THINK AND LISTEN



#### SESSION: 5 minutes p/p



#### THINK AND LISTEN



#### SESSION: 1 minute p/p



## 8 GOOD AND LEARN

Participants don't let what we have learned go to waste. That is why we do 'good and learn'.

This is not a time for evaluation. Participants do not say 'I did not do well' or 'I did not understand'. But they do say what was good for them and what they learned from today's peer counselling.



**SESSION:**

1 minute p/p (depending on time available)



## 9 APPRECIATION

Persons with disabilities don't get praised often in our daily life. So we will have an opportunity to be appreciated by one another here.



### WHAT IT MEANS TO BE APPRECIATED

Appreciation is getting to know one another, to encourage one another, show love and support. This is so that we can feel we are important and valuable. We can regain our self-esteem and confidence.

Please take some care when you praise one another:

- Be careful not to compare disabilities, gender, past history, future prospects, age, and other persons, including yourself. Do not lecture or give advice.
- Don't be too modest or embarrassed. We should accept being appreciated and be able to appreciate ourselves. Everyone has something worth praising, so don't feel bad or shy when you are being praised: Feel you deserve your praise.

Make a circle and appreciate one another, one by one.

Decide who will be praised first. Then each participant praises that person (30 seconds p/p). After everyone has praised the person, that person says how they feel about being appreciated.

## SUPPORT MATERIALS FOR LEADERS WITH DISABILITIES

---

### How to start a support group

#### Guideline

Support groups provide a useful forum for people to share their experiences, access information and increase understanding about a common problem.

#### What is the focus of the group?

You need to decide on a clear focus for the group. You will be more successful if you offer a group with a specific focus such as parents of children with learning difficulties or a rape survivor support group, as opposed to a more general group with an undefined focus.

Ask yourself:

- What is the problem?
- Who needs support?
- Who should attend?
- What would you like to achieve?

#### An accessible venue and appropriate time

Choose a venue that is central. If you cannot find a suitable public venue, you could decide to have your meetings at members' homes.

Choose a time that would suit most members.

#### Getting your group together

Once you have decided on a focus, you need to recruit members. Advertise in the local press, on social media, at a public clinic, library, community centre, or at places where new members of the group are likely to go.

#### Decide on the size of the support group

The size of a support group is important. If your group is too big, some members will never have the opportunity to contribute. Rather split the group into two or more manageable groups. If the group is too small, there is a chance that your group will dissolve due to absenteeism and dropping out.

#### Your first meeting

Use the first meeting to find out what people would like to gain from the group. Your group will be more successful if you take the issues they are concerned about into account.

#### Share the responsibility

Don't take on all the responsibility. You will soon feel overburdened. Elect a coordinator, treasurer and secretary. You could also decide to re-elect people every year. Apart from preventing burnout, sharing of responsibility will also give more people the chance to become involved in the group.

## Prevent drop out

Many support groups stop functioning due to lack of interest. Keep your members active and interested by having a range of activities or topics. Here are some suggestions:

- Invite guest speakers to some of your meetings.
- Follow up on your members' suggestions. People can easily become demotivated and feel undervalued if one member takes all decisions and responsibility for the group.
- Give your members a chance to suggest topics and organise meetings. Encourage participation by giving members the opportunity to share their own experiences and knowledge. Depending on the nature of the group, members could bring something they have made along or share tips on how they dealt with specific problems.
- Organise social events. This will give you a chance to get to know one another in a more relaxed atmosphere. You could also invite members of similar support groups.



## Create a safe place for feelings

Many people were taught that some feelings are acceptable and others are not. Some feelings are negative and others are positive, and that somehow we need to be rescued from our feelings, especially painful ones such as anger, sadness, hurt, fear, hopelessness, helplessness, and guilt. Many people have had their feelings shamed in their family of origin and have anxiety about risking sharing feelings in a group.

When the following basic principles about feelings are honoured, safety for feelings can be created in a relationship or a group:

- Feelings are neither right nor wrong, good nor bad. All feelings are allowable and do not require either a negative or positive judgement.
- Feelings are meant to be passing visitors, they are not meant to take up permanent residence in our minds.
- Telling someone they should or shouldn't feel something does not help them, but rather causes feelings to become distorted or blocked.
- Feelings can be released when they are heard with compassion, empathy, respect, and a lack of judgement. This is what unconditional presence means.



### REFERENCE

This material and the content of the Peer Counsellor Training was designed based on the peer counsellor guidelines developed by the Human Care Association (Japan) and revised by Mr July Mathebula, peer counsellor.



## TOOL 5

# FACILITATION GUIDE ON DISABILITY AWARENESS FACILITATOR TRAINING

### 1 BACKGROUND

---

The disability awareness activity aims to promote the social model of disability. The social model of disability is a key perspective in advancing the empowerment of persons with disabilities and disability mainstreaming. The social model sees disability as a social construct, with disability arising not from individuals, but from a social environment where diversity is not respected.

Through disability awareness activities, people discover that disability is in society and not in the person, and that the solution to disability is social change that involves removing the barriers which hinder the participation of persons with disabilities in our society. This perspective is called the social model of disability.

*(Note: In contrast to the social model, the medical/individual model of disability emphasises the impairment that the person has. Responses and service delivery are designed to 'fix' the person, and generally separates them from the rest of society.)*

### 2 OBJECTIVES

---

- To deepen understanding of the social model of disability
- To learn how to facilitate disability awareness activities through practice.

### 3 TARGET PARTICIPANTS

---

- Potential leaders with disabilities in the implementation site
- The number of participants is recommended to be fewer than 15 persons for well-managed training and to better achieve the objectives.
- **On the last day** of the training, **stakeholders such as government officials participate** in the programme (see Day 3 of the following example).

### 4 RECOMMENDED ORGANISERS AND DEMARCATION

---

Organisers are drawn from district DSD and municipalities in collaboration with provincial DSD and the working group. The recommended demarcation is as follows:

- a) District DSD and municipalities in collaboration with provincial DSD and the working group
  - Nomination of participants with disabilities
  - Arrangement of accessible venue, transport for participants and catering
  - Communication and coordination with a trainer
  - Dispatch of a trainer(s) (consultation with national DSD if needs arise)

b) Trainer(s)

- Development of programme and materials
- Facilitation of the training
- Development and submission of report on the training to the organisers.

## 5 PROGRAMME EXAMPLE

The length of the workshop should be three days to achieve the training purposes. An example of the programme is as follows:



DAY 	TIME 	ITEM 
DAY 1	09:00–09:30	Welcome and introductions
	09:30–10:00	Purpose and background
	10:00–12:00	Demonstration of disability awareness activity by the trainer
	12:00–13:00	Lunch break
	13:00–14:30	How to conduct a disability awareness activity <ul style="list-style-type: none"> <li>• Detailed explanation of each exercise</li> </ul>
	14:30–15:30	Materials development
	15:30–16:00	Q & A
DAY 2	10:00–10:30	Recap of Day 1 of the workshop
	10:00–12:00	Practice of disability awareness activity by participants
	12:00–13:00	Lunch break
	13:00–15:30	Practice of disability awareness activity by participants
	15:30–16:00	Q & A
DAY 3	09:30–10:00	Recap of Day 2 of the workshop
	10:00–12:00	Demonstration of disability awareness activity by participants <ul style="list-style-type: none"> <li>• Government officials and other stakeholders participate in the activity</li> </ul>
	12:00–13:00	Development of new disability awareness activity plan
	13:00–	Way forward and closing

## 6 EQUIPMENT/MATERIALS REQUIRED

The following equipment and materials are required for Disability Awareness Facilitator Training:

- Paper and pens (for Exercises 1 and 2)
- Coloured Post-it notes (for Exercise 2)
- Scissors, sticky tape, coloured pens, big sheets paper and cardboard box(es) (for materials development in the training)
- Laptop, projector and screen (If it is difficult to provide a projector and laptop, hand-made materials could be used. See 7.2 Materials development on page 89.)

## 7 TRAINING CONTENT

The training has three main components: 1) Overview of disability awareness activity (Day 1); 2) Practice of disability awareness activity (Day 2); and 3) Demonstration of disability awareness activity (Day 3).

### 7.1 Overview of disability awareness activity (Day 1)

Participants experience disability awareness activity demonstrated by a trainer firstly. After that, participants learn about how to conduct a disability awareness activity including the facilitation points of the activities.

#### 7.1.1 EXERCISE 1: What is disability?

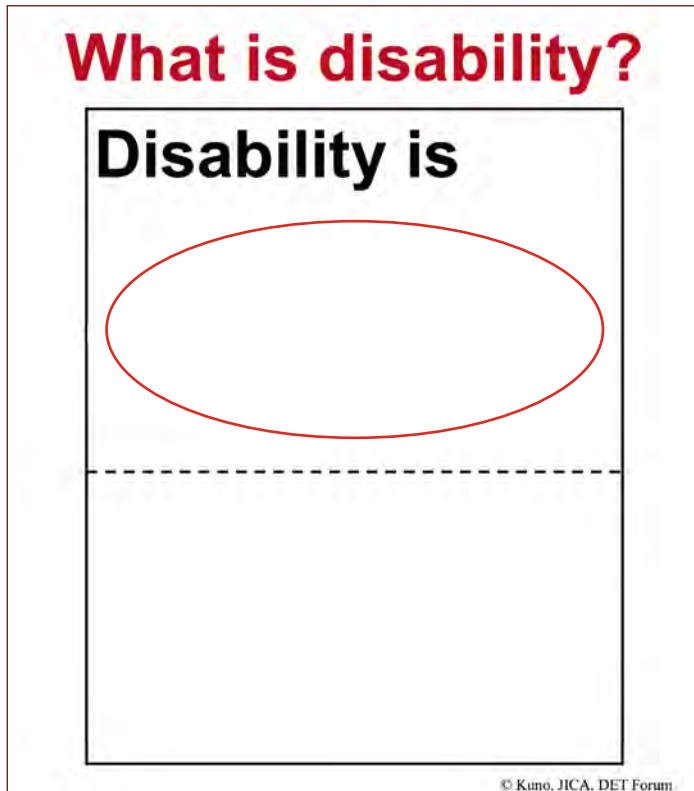

Participants write their own answer to the question: 'What is disability?' (i.e. their own explanation of disability) in the top half of the paper.

The answers are shared among the participants. There are no correct or wrong answers. (Keep the paper until the end of this exercise session; it will be used again later.)

*Tip for the facilitator: The facilitator asks participants to consider and write an answer to: 'What is the disability?' The answer should be 'disability is ...' NOT 'persons with disabilities are ...'*



### 7.1.2 EXERCISE 2: What is disability?/Where is disability?

The first slide shows only a boy using a wheelchair.



#### What is disability?

Participants discuss **what** the disability is in groups/ as individuals, and share their answers.

#### Where is disability?

Next, the participants discuss **where** the disability is in groups/as individuals.



#### Location of disability

Each group or individual decides the location of disability, and takes a small piece of paper (like a Post-it note) and puts it on the location of disability, as shown in the illustration.

The second slide shows the same wheelchair user, but he is now in front of stairs. There is a shop window on his left. It is obvious that the entrance to the shop is at the top of the stairs.



#### What is disability?

Participants discuss **what** the disability is in groups/ as individuals, and share their answers.

#### Where is disability?

Next, the participants discuss **where** the disability is in groups/as individuals.

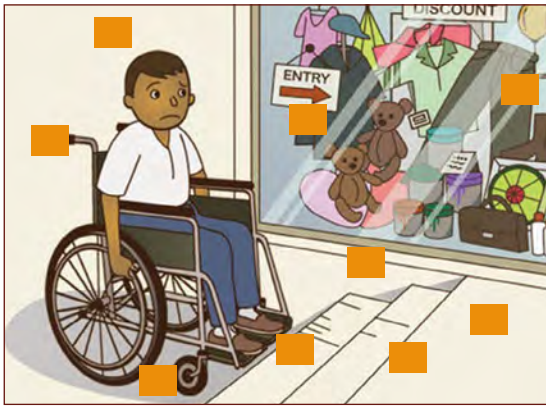

### Location of disability

Each group or individual decides the location of disability and puts a small piece of paper (like a Post-it note) to mark the location of disability as shown in the illustration in the slide.

*Tip for the facilitator:* The facilitator asks: 'What is the **problem?**' and 'Where is the **problem?**' if it is difficult for the participants to decide the location of disability.

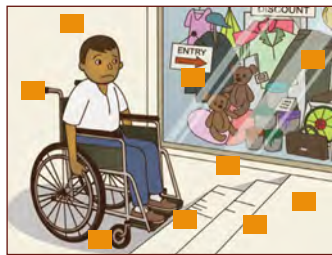

Participants compare the first and the second slides, and recognise that their perspectives on disability have changed.

Participants should now understand disability from social model perspective through this exercise

*Tip for the facilitator:* The facilitator does not provide the answers. Be aware of the difference between the two questions 'what' and 'where'. Before the conclusion of this exercise, summarise the difference between the two illustrations. The key message is that disability is not in the person, but in society.

### 7.1.3 EXERCISE 3: What is disability?

## What is disability?

### Disability is

© Kuno, JICA, DET Forum

Participants reconsider and rewrite their explanation of disability in the bottom half of the paper.

Participants now share their own explanations, and discuss the changes of explanation between what they wrote first and what they wrote second.

# Disability

results from the interaction between persons with impairments and **attitudinal and environmental barriers** that hinders their full and effective **participation** in society on an **equal basis** with others (UNCRPD)

12  
© Kuno, JICA, DET Forum

The UNCRPD recognises disability as an evolving concept and states that “disability results from the interaction between persons with impairments and attitudinal and environmental barriers that hinders their full and effective participation in society on an equal basis with others”. This reflects the perspective of the social model of disability.



*Tip for the facilitator:* The facilitator shows the similarity between what participants have discovered and what the UN says. This will encourage and motivate participants when they realise the real meaning of ‘disability’.

## 7.1.4 EXERCISE 4: How do you solve?

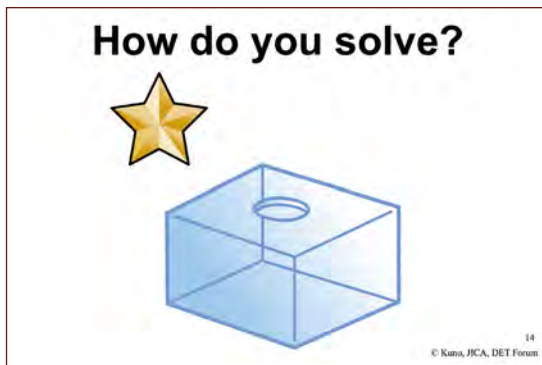

The first slide shows a star-shaped object and a box which has a hole that is smaller than the object.

Participants discuss in groups/as individuals how to put the star-shaped object into the box.

*Tip for the facilitator:* The facilitator explains the task: to put the star into the box although the star is bigger than the hole in the box. Do not use the terms ‘disability’ and ‘society’ at this stage.

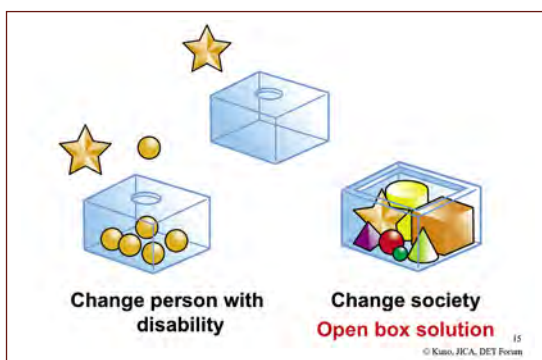

The second slide shows two ways to resolve the situation: One is to adjust/change the star, e.g. by cutting up the star to put it into the box. The other is to adjust/change the box, e.g. by opening the hole/box to put the whole star into the box.

Participants understand that the star represents a person with disability and the box represents their community/environment; they discuss how they want to resolve the situation.

Participants will agree that the community should be changed to accept persons with disabilities. In addition, it should be highlighted that if the community is changed, various shapes of objects will be accommodated, as shown in the illustration.

*Tip for the facilitator:* The facilitator elicits the following points:

- Both solutions can complete the task but the result is different.
- Which would you like to change, the person with disability or society/environment?
- Which result would you like to create: only one shape can be accommodated; or various types of shapes can be accommodated?
- The key message is to change society, not to change persons with disabilities.

### 7.1.5 EXERCISE 5: Listen to the voices of persons with disabilities

**Why does it happen?**



**Listen to/ask for users' voices!**

© Kamo, JICA, DET Forum

The picture in the slide shows a woman using a wheelchair, trying to go up a ramp but not being able to do so.

#### What is the problem/Why does it happen?

Participants analyse what the problem is and why it is happening. They could answer any of the following: 'The problem is the ramp that is too steep', 'Wheelchair users were not considered when the ramp was made', 'If wheelchair users were involved in designing the ramp, they could show the appropriate gradient to use'.

Participants start to understand that the involvement of persons with disabilities is important.

*Tip for the facilitator: The facilitator asks participants, 'Why does this happen?' and 'Why is the ramp too steep?' The key message is when you change anything in the environment, you should listen to the voices of persons with disabilities.*

### 7.1.6 Conclusion

**Disability is**



Participants now understand the social model. The social model says disability arises from a social environment where diversity is not respected.

They also recognise two key points in developing an activity plan: i.e. Change society; and Listen to the voices of persons with disabilities.

#### Overall tips for the facilitator:

- *Participatory: Facilitation is important (do not provide answers, but encourage participants to think and speak, i.e. 'discover' their own answers).*
- *Include your personal story in relating important messages.*
- *You are not teaching, instead you also learn from the audience.*

**Two Key Points**

- 1. Change society  
(not person with disability)**
- 2. Listen to the voices of  
persons with disabilities**

© Kamo, JICA, DET Forum



## 7.2 Materials development (Day 1)

Group and/or individual work is conducted in this disability awareness activity. The organisers should prepare the materials and equipment for the activity such as paper, pens, coloured Post-it notes, as well as a projector and laptop.



[Photo 1] Hand-drawn picture for Exercise 1: Where is disability?



[Photo 2] Hand-made box and star for Exercise 4: How do you solve?

If it is difficult to provide a projector and laptop, you could use hand-made materials such as hand-drawn pictures and a box instead of using PowerPoint slides [Photos 1 and 2].

In the training, participants create the following hand-made materials during the session for materials development on Day 1:

- Hand-drawn pictures showing a boy using a wheelchair in front of stairs: Exercise 1 (What is disability?/Where is disability?)
- Hand-made star and box: Exercise 4 (How do you solve?)
- Hand-drawn pictures showing a woman using a wheelchair trying to go up a steep ramp: Exercise 5 (Listen to the voices of persons with disabilities)

Participants are recommended to divide into small groups to develop one or two materials from the above-mentioned materials in groups.

## 7.3 Practice of disability awareness activity by participants (Day 2)

Participants practise how to facilitate disability awareness activity. Participants divide into two to four groups so that all participants have experience in the practice of presentation and facilitation. In the practice session: firstly, five persons facilitate the exercises from 1 to 5 in order. After that, another five persons facilitate the exercises from 1 to 5, and so on.

## 7.4 Demonstration of disability awareness activity by participants (Day 3)

Participants conduct the disability awareness activity for government officials and other stakeholders. This is a practice session for the training participants. In addition, this session aims to promote understanding and support from officials of DSD, municipalities and other stakeholders, for long-term sustainability of disability awareness activities.



## 8 AFTER THE TRAINING: FURTHER DISABILITY AWARENESS ACTIVITIES BY TRAINED PERSONS WITH DISABILITIES

The trained persons with disabilities can now conduct disability awareness activities to promote the social model of disability, as well as to improve their skills through practical activities. It is recommended that several trained facilitators together as a team facilitate further disability awareness activities to assist one another.

The participants are expected to be community people and representatives from any organisations in the implementation site, such as public institutions, schools, taxi associations, NGOs, and private companies. The length and content of the disability awareness activities should be discussed and decided by the facilitators and stakeholders. A minimum of two hours is needed.

### Organisers

The organisers are drawn from district DSD and municipalities, in collaboration with the working group. The recommended demarcation of responsibilities is as follows:

- a) District DSD and municipalities in collaboration with the working group:
  - Obtain buy-in from key stakeholders to conduct the activities
  - Arrange accessible venue, transport for participants, and catering
  - Communication and coordination with trained facilitators.
- b) Facilitators (trained persons with disabilities)
  - Development of programme and materials
  - Facilitation of disability awareness activity
  - Sharing of the outcomes of disability awareness activities with the organisers.

### Programme example

The following programme shows an example of a three-hour session.

TIME 	PROGRAMME 
10h00–10h20	Welcome and introductions
10h20–10h30	Purpose of today's activities
10h30–10h50	Exercise 1: What is disability?
10h50–11h30	Exercise 2: What is disability? / Where is disability?
11h30–11h50	Exercise 3: What is disability?
11h50–12h20	Exercise 4: How do you solve?
12h20–12h40	Exercise 5: Listen to the voices of persons with disabilities
12h40–13h00	Conclusion and Q & A





## REFERENCES

The content and PowerPoint slides for the disability awareness activities were designed based on Disability Equality Training (DET) guidelines whose methods, materials and content used in the project were developed by JICA and Dr Kenji Kuno, a representative of DET Forum (<http://detforum.com/>).

Kuno, Kenji. 2012. *Doing Disability Equality Training*. Kuala Lumpur: MPH Publishing. (DET Manual No. 6) <http://detforum.com/intl/wp-content/uploads/2009/03/Doing-Disability-Equality-Training.pdf>



A person with disabilities practises conducting a disability awareness activity (Limpopo)



**TOOL 6**

# Disability Awareness Activity

Building a Caring Society. Together.

[www.dsd.gov.za](http://www.dsd.gov.za)



The content and PowerPoint slides for the disability awareness activities were designed based on Disability Equality Training (DET) guidelines whose methods, materials and content used in the project were developed by JICA and Dr Kenji Kuno, a representative of DET Forum (<http://detforum.com/>).



## After the training:

**We take action to make our community/environment inclusive and accessible!**

# Exercise 1



3

© Kuno, JICA, DET Forum

## What is disability?

**Disability is**

4

© Kuno, JICA, DET Forum

# Exercise 2

5

© Kuno, JICA, DET Forum

## What is disability?



## Where is disability?

6

© Kuno/JICA/DET Forum



# What is disability?



# Where is disability?

7

© Kuno/JICA/DET Forum

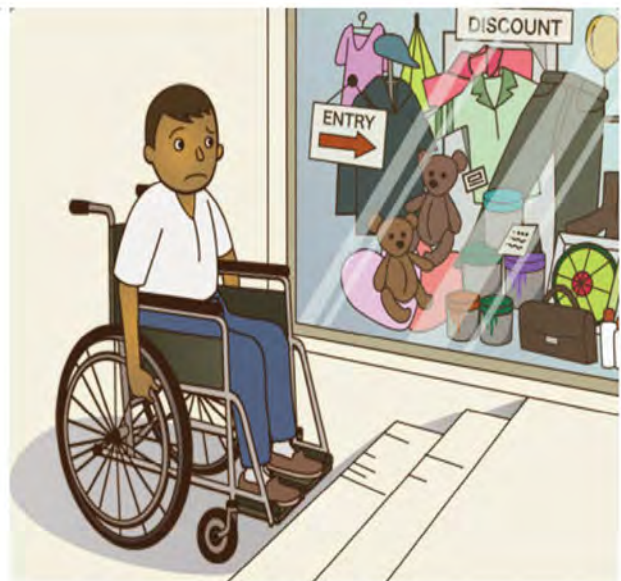

8

© Kuno/JICA/DET Forum

# Exercise 3

9

© Kuno, JICA, DET Forum

## What is disability?



## Where is disability?

10

© Kuno, JICA, DET Forum



# What is disability?

**Disability is**

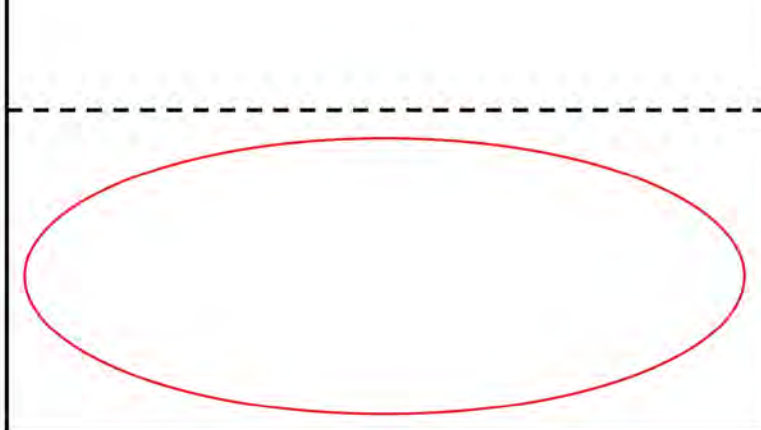

11

© Kuno, JICA, DET Forum



## Disability

results from the interaction between persons with impairments and **attitudinal and environmental barriers** that hinders their full and effective **participation** in society on an **equal** basis with others (UNCRPD)

12

© Kuno, JICA, DET Forum

# Exercise 4

13

© Kuno, JICA, DET Forum

## How do you solve?

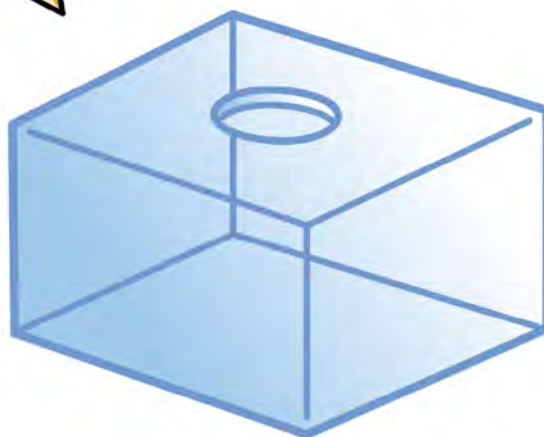

14

© Kuno, JICA, DET Forum

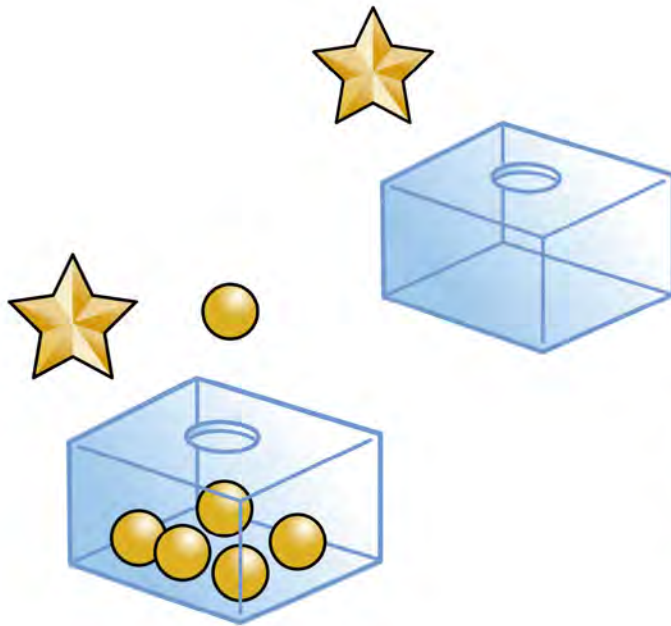

**Change person with disability**

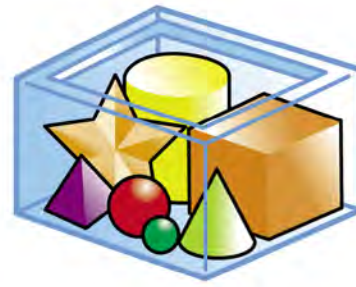

**Change society**  
**Open box solution**

15

© Kuno, JICA, DET Forum

# Exercise 5

16

© Kuno, JICA, DET Forum

## Why does it happen?



**Listen to/ask for users' voices!**

17

© Kuno, JICA, DET Forum

# Conclusion

18

© Kuno, JICA, DET Forum

# Disability is



19

Kuno, JICA, DET Forum



## Two Key Points

- 1. Change society  
(not person with disability)**
- 2. Listen to the voices of  
persons with disabilities**

20

© Kuno, JICA, DET Forum



**Nothing about us,  
without us!**

**We will change  
society!**

21





Persons with disabilities raise awareness on disability at a high school (Limpopo)



## TOOL 7

## QUESTIONNAIRE FORM FOR BASELINE SURVEY

### INFORMED CONSENT

We are here to conduct a baseline survey to deepen our understanding of barriers to participation of persons with disabilities. The outcome of the survey will be used for planning and implementing activities on the empowerment of persons with disabilities and disability mainstreaming. All information provided by you in this questionnaire will be used under standards of strict confidentiality and without any mention of your name.

We would like to ask you some questions about your needs and challenges as a person with disability in your community. You have been randomly selected to participate in this survey.

This questionnaire will probably take about 20 minutes. This questionnaire is voluntary with informed consent and has no risk for you or your family. You can refuse to answer any questions. Also, you can choose not to continue answering questions in the questionnaire at any time.

It is important for you to understand that you will not receive any financial benefit from answering the questionnaire. However, persons with disabilities in South Africa will benefit from your participation because the survey results will be used for developing activity plans to promote empowerment of persons with disabilities and disability mainstreaming

I understand the terms of the informed consent and I agree to participate in this survey.

Name of Respondent: \_\_\_\_\_

*(this will not be shown in any report on survey results)*

Signature: \_\_\_\_\_

Date: \_\_\_\_ / \_\_\_\_ / \_\_\_\_

Please tick  the answer that reflects your experience, or write your answer/comments in the space provided.

SECTION A: IDENTIFICATION AND BACKGROUND INFORMATION		
A1	Address: (Only the name of municipality, ward and village)	Municipality: Ward: Village:
A2	Contact telephone number	
A3	Gender	1. <input type="checkbox"/> Female 2. <input type="checkbox"/> Male
A4	Age	(       ) years
A5	Current status	1. <input type="checkbox"/> Student, specify (       ) 2. <input type="checkbox"/> Working, specify occupation (       ) 3. <input type="checkbox"/> Stay at home, specify (       ) 4. <input type="checkbox"/> Other, specify (       )
A6	What is your impairment/ disability? (Multiple answers allowed)	1. <input type="checkbox"/> Visual 2. <input type="checkbox"/> Hearing 3. <input type="checkbox"/> Physical 4. <input type="checkbox"/> Intellectual/psychosocial 5. <input type="checkbox"/> Other, specify (       )



SECTION B: ACCESSIBILITY		
<b>Relevance to the WPRPD: Pillar 1 – Removing Barriers to Access and Participation</b>		
<b>Focus Area: Access to the built environment</b>		
B1	What facilities do you want to improve accessibility? (Multiple answers allowed)	1. <input type="checkbox"/> Housing (e.g. own, relative's, friend's, neighbour's) 2. <input type="checkbox"/> Healthcare facilities (e.g. clinic, hospital, rehabilitation centre) 3. <input type="checkbox"/> Education facilities (e.g. school, college, university) 4. <input type="checkbox"/> Workplaces 5. <input type="checkbox"/> Markets and shops 6. <input type="checkbox"/> Public/community facilities (e.g. local government offices, church/mosque/temple, community centre) 7. <input type="checkbox"/> Other, specify (       )
<b>Relevance to the WPRPD: Pillar 1 – Removing Barriers to Access and Participation</b>		
<b>Focus Area: Access to transport</b>		
B2	What difficulties do you experience with modes of transport? (Multiple answers allowed)	1. <input type="checkbox"/> Public transport far away from my home 2. <input type="checkbox"/> Difficulty in getting on board 3. <input type="checkbox"/> Difficulty in getting information about appropriate transport 4. <input type="checkbox"/> Negative attitude of drivers, staff or passengers 5. <input type="checkbox"/> Other, specify (       )
<b>Relevance to the WPRPD: Pillar 1 – Removing Barriers to Access and Participation</b>		
<b>Focus Area: Access to information and communication</b>		
B3	What difficulties do you experience in accessing information and communication in relation to your impairment and disability?	Specify (e.g. no Braille service/sign language, etc.)

## SECTION C: HEALTH

**Relevance to the WPRPD: Pillar 4 – Promoting and Supporting Empowerment of Persons with Disabilities**  
**Focus Area: Access to healthcare and lifestyle support**

<b>C1</b>	<p>What difficulties do you experience with healthcare?          (Multiple answers allowed)</p>	<ol style="list-style-type: none"> <li>1. <input type="checkbox"/> Healthcare facilities far away from my home</li> <li>2. <input type="checkbox"/> Building is not accessible</li> <li>3. <input type="checkbox"/> Healthcare provider's skills were not adequate to meet my needs on impairment and disability</li> <li>4. <input type="checkbox"/> Difficulty in getting information about appropriate healthcare</li> <li>5. <input type="checkbox"/> Negative attitude of healthcare providers</li> <li>6. <input type="checkbox"/> Other, specify ( )</li> </ol>
-----------	---	--

## SECTION D: EDUCATION

**Relevance to the WPRPD: Pillar 4 – Promoting and Supporting Empowerment of Persons with Disabilities**  
**Focus Area: Early childhood development/Lifelong education and training**

<b>D1</b>	<p>What difficulties do you experience in education?          (Multiple answers allowed)</p>	<ol style="list-style-type: none"> <li>1. <input type="checkbox"/> Education facilities far away from my home</li> <li>2. <input type="checkbox"/> Building is not accessible</li> <li>3. <input type="checkbox"/> Textbooks and materials are not accessible</li> <li>4. <input type="checkbox"/> Teachers' teaching skills were inadequate to meet my needs on impairment and disability</li> <li>5. <input type="checkbox"/> Difficulty in getting information about appropriate education</li> <li>6. <input type="checkbox"/> Negative attitude of teachers or classmates</li> <li>7. <input type="checkbox"/> Other, specify ( )</li> </ol>
-----------	--	---

## SECTION E: LIVELIHOOD

**Relevance to the WPRPD: Pillar 5 – Reducing Economic Vulnerability and Releasing Human Capital**  
**Focus Area: Access to decent work and work opportunities**

<b>E1</b>	<p>What difficulties do you experience in employment and at work?          (Multiple answers allowed)</p>	<ol style="list-style-type: none"> <li>1. <input type="checkbox"/> Workplace far away from my home</li> <li>2. <input type="checkbox"/> Building is not accessible</li> <li>3. <input type="checkbox"/> Documents and equipment are not accessible</li> <li>4. <input type="checkbox"/> Difficulty in communication with colleagues or customers</li> <li>5. <input type="checkbox"/> Negative attitude of colleagues or customers</li> <li>6. <input type="checkbox"/> Never been employed</li> <li>7. <input type="checkbox"/> Other, specify ( )</li> </ol>
-----------	---	--

**Relevance to the WPRPD: Pillar 5 – Reducing Economic Vulnerability and Releasing Human Capital**  
**Focus Area: Disability, poverty, development and human rights**

<b>E2</b>	<p>What difficulties do you experience with the disability grant?          (Multiple answers allowed)</p>	<ol style="list-style-type: none"> <li>1. <input type="checkbox"/> Grant office far away from my home</li> <li>2. <input type="checkbox"/> Building is not accessible</li> <li>3. <input type="checkbox"/> Documents are not accessible</li> <li>4. <input type="checkbox"/> Difficulty in getting information on disability grant</li> <li>5. <input type="checkbox"/> Negative attitude of staff</li> <li>6. <input type="checkbox"/> Never received disability grant</li> <li>7. <input type="checkbox"/> Other, specify ( )</li> </ol>
-----------	---	--









## SECTION H: OTHERS

H1	What is the <b>biggest challenge</b> for you in relation to your impairment and disability?	
H2	If you have any other comments on or concerns about disability, please describe here.	

End of questionnaire. Thank you for your cooperation.



A DSD official talks with people in the community (Eastern Cape)



## TOOL 8

### EXAMPLE OF REPORT ON RESULTS OF THE BASELINE SURVEY

Name: \_\_\_\_\_

Date: \_\_\_\_ / \_\_\_\_ / \_\_\_\_

Organisation and position: \_\_\_\_\_

Implementation site (name of local municipality and district): \_\_\_\_\_

#### 1. Number of questionnaire respondents

		NUMBER OF ANSWERS	PERCENTAGE
1	Number of women who answered	23 people	55%
2	Number of men who answered	19 people	45%
3	<b>Total number of respondents to the questionnaire</b>	<b>42 people</b>	<b>(100%)</b>

#### 2. Age

<b>Average age of respondents</b>	36 years
-----------------------------------	----------

#### 3. Current status

		NUMBER OF ANSWERS	PERCENTAGE
1	Student	4 answers	10%
2	Working	7 answers	17%
3	Stay at home	28 answers	67%
4	Other	3 answers	7%
5	<b>Total number of answers (1+2+3+4)</b>	<b>42 answers</b>	<b>(100%)</b>

#### 4. Number and percentage of each impairment

		NUMBER OF ANSWERS	PERCENTAGE
1	Persons with visual impairment	4 answers	10%
2	Persons with hearing impairment	2 answers	5%
3	Persons with physical impairment	29 answers	69%
4	Persons with intellectual/psychosocial impairment	4 answers	10%
5	Persons with other impairments	3 answers	7%
6	<b>Total number of answers (1+2+3+4+5)</b>	<b>42 answers</b>	<b>(100%)</b>



#### 5. Presenting the challenges derived from the questionnaire survey

- The survey results indicate that participants experience challenges with infrastructure especially in the workplace. This indicates that the developed structures are not disability friendly which results in limited employment opportunities for persons with disabilities in the working sector.
- Transport is also identified as one of the challenges since available transport modes and systems are not disability friendly. Transport modes are also far away from where people are based which makes it difficult for persons with disabilities to access them.
- Those members with visual impairments experience challenges with accessing information as it often presented in small print or unreadable formats.
- In respect of education, persons with disabilities expressed the challenges of negative attitudes from teachers which can result in them not accessing education as they should be.
- The factors described above contribute to a majority of participants being unemployed, and never having been employed.
- Persons with disabilities experience challenges with getting to SASSA offices which are far away from where they live.
- There is little or minimal community consultation with persons with disabilities as the survey indicated that they have little community participation.
- However, although consultation needs to be strengthened, persons with disabilities know their rights very well and still get respect from the community.
- The survey also indicates that persons with disabilities have full control in their own decision-making as they are empowered.
- 50 per cent of the participants indicated that they are involved socially every day.



## TOOL 9

# FACILITATION GUIDE ON DEM INTRODUCTORY WORKSHOP: TO DEVELOP AN ACTIVITY PLAN

### 1 OBJECTIVES

---

- To understand the empowerment of persons with disabilities and disability mainstreaming (DEM) approach and begin activities using the DEM approach
- To understand disability based on the social model perspective
- To develop an activity plan to address barriers faced by persons with disabilities.

### 2 TARGET PARTICIPANTS

---

DEM working group members from the implementation site are the intended participants.

### 3 ORGANISERS

---

Organisers are drawn from district DSD and municipalities in collaboration with provincial DSD and the working group. Roles of the organisers are as follows:

- Arrange accessible venue, transport for participants, and catering
- Communicate and coordinate with the working group members, and invite them as the participants
- Develop a programme and materials
- Facilitate the training
- Develop a training report and share it with the stakeholders.

### 4 FACILITATORS

---



Facilitators are drawn from provincial and district DSD officials (in consultation with national DSD if the need arises).

## 5 EQUIPMENT AND MATERIALS REQUIRED

The following equipment and materials are required for DEM introductory workshop

- Large sheets of paper and pens (for development of activity plans by groups)
- Paper and coloured Post-it notes (for disability awareness activity)
- Laptop, projector and screen

## 6 PROGRAMME EXAMPLE

DAY 	TIME 	ITEM 
DAY 1	10:00–10:20	Welcome and introductions
	10:20–12:00	Overview and concept of the DEM approach <ul style="list-style-type: none"> <li>• Three fundamental principles</li> <li>• Implementation steps</li> <li>• Social model of disability (recap of disability awareness activity)</li> <li>• DEM activity examples</li> </ul>
	12:00–13:00	Lunch break
	13:00–13:30	Report on results of the baseline survey
	13:30–14:00	Presentation on the activity plan template
	14:00–15:30	Identification of strong barriers to participation of persons with disabilities in the implementation site
	15:00–16:00	Development of activity plans
DAY 2	10:00–10:15	Recap of Day 1 of the workshop
	10:15–12:00	Development of activity plans (continue from where we left off yesterday)
	12:00–13:00	Lunch break
	13:00–14:00	Presentation of activity plans
	14:00–15:00	Consolidation and finalisation of activity plan
	15:00–15:30	Confirm next activity with concrete timeframe
	15:30–	Way forward and closing



## 7 PROGRAMME CONTENT

The programme has three main components: 1) Overview of the DEM approach; 2) Understanding of the social model of disability; and 3) Development of an activity plan based on results of the baseline survey.

### 7.1 Overview and concept of the DEM approach

The facilitator (provincial/district DSD official) explains and gives an outline of the DEM approach such as the background, concept, implementation steps and activity examples, as well as the relevant policy framework. In addition, the facilitator explains the social model of disability which is a key perspective in promoting the DEM approach.

The DEM approach was developed by DSD and JICA through a technical cooperation project, 'Promotion of Empowerment of Persons with Disabilities and Disability Mainstreaming (2016–2020)'. The DEM project was implemented at four study sites:

**SITE 1** Collins Chabane municipality, Vhembe district, Limpopo province

**SITE 2** Maluti-a-Phofung municipality, Thabo Mofutsanyana district, Free State province

**SITE 3** Nyandeni municipality, OR Tambo district, Eastern Cape province

**SITE 4** Mandeni municipality, iLembe district, KwaZulu-Natal Province.

The DEM approach is a way to empower persons with disabilities and create a platform for persons with disabilities, government, municipalities and other key stakeholders, in order to realise the participation of persons with disabilities in mainstreaming at district and local level.

#### 7.1.1 Concept of the DEM approach

### Concept of Empowerment of Persons with Disabilities and Disability Mainstreaming (DEM) approach

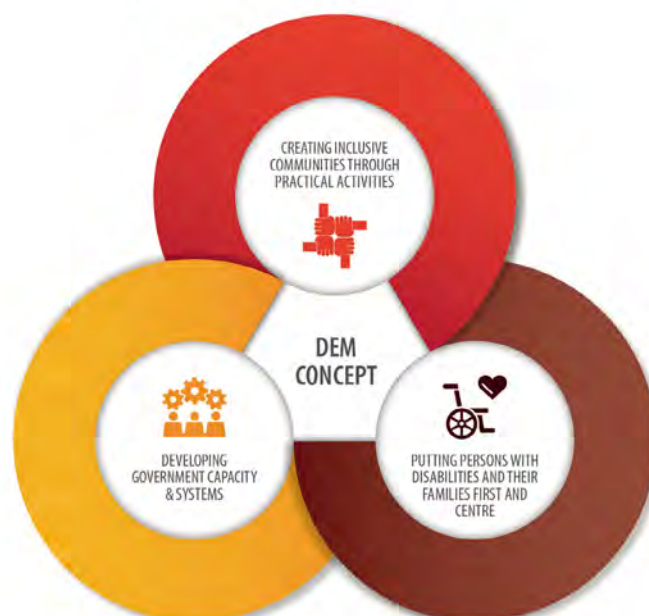

2



The concept behind the DEM approach rests on three fundamental principles that make up this unique approach to empowering persons with disabilities and mainstreaming disability:

- Putting persons with disabilities and their families first and centre
- Developing government capacity and systems
- Creating an inclusive community through practical activities.

### **PRINCIPLE 1: Putting persons with disabilities and their families first and centre**

One of the major challenges that persons with disabilities face is a lack of self-representation and exclusion from education, training and employment. It follows then that in any programme that aims to empower persons with disabilities and promote disability mainstreaming, persons with disabilities and their families must be the main actors. The DEM approach puts persons with disabilities and their families first and centre, in line with the principle, 'Nothing about us, without us'. Building on this foundation, activities for the empowerment of persons with disabilities and their families should be implemented first.



### **PRINCIPLE 2: Developing government capacity and systems**

The United Nations (UN) defines mainstreaming as the process of assessing the implications for persons with disabilities of any planned action, including legislation, policies or programmes, in any area and at all levels. Thus it is essential to capacitate government officials to mainstream disability in any and all government policies and programmes, and to create sustainable systems for disability mainstreaming. The DEM approach aims to develop the capacity, mindset, and skills of government officials, and to establish sustainable systems of government to underpin activities on empowerment of persons with disabilities and disability mainstreaming.

### **PRINCIPLE 3: Creating an inclusive community through practical activities**

The DEM approach places value on community-based activities which pay attention to the lives of persons with disabilities especially concerning their participation in all aspects of community life. This is because a sectoral, top-down approach would not be sufficient or appropriate for the full participation of persons with disabilities.

In the DEM approach, the barriers faced by persons with disabilities need to be brought out, and these barriers should be addressed by persons with disabilities and other stakeholders in their communities. To this end, barriers are identified through a baseline survey which is conducted in their communities. Then training for persons with disabilities and stakeholders is conducted to capacitate them to address the identified barriers. The training is not just theoretical but always features a hands-on, practical component where participants learn through applied activities.

The DEM approach is versatile enough to be adapted to different environments and circumstances at any level, area and sector.

## 7.1.2 DEM Implementation steps

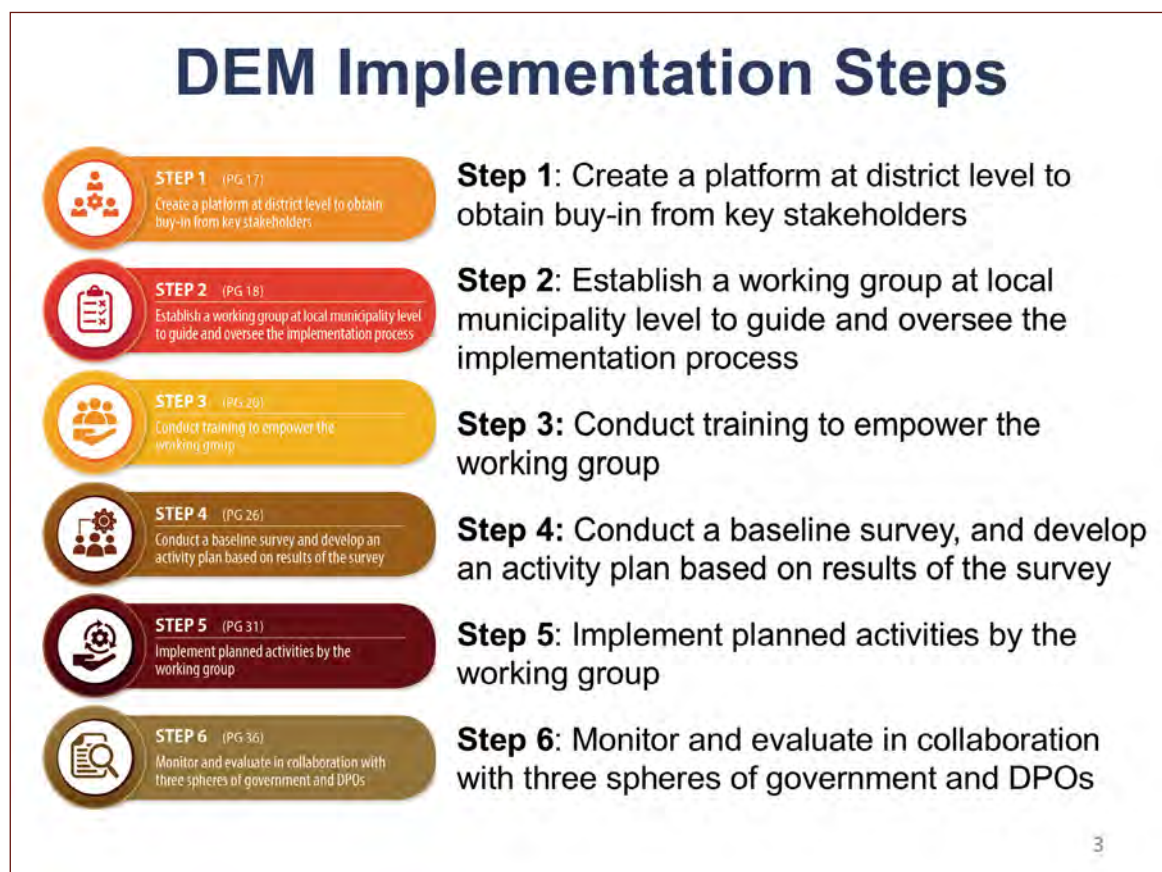

The implementation flow of the DEM approach can be described in six steps. An important reminder is that at every step of this process, persons with disabilities and their families should be placed first and centre, and be active members of all discussions and activities.

The DEM implementation steps are as follows:

- STEP 1** Create a platform at district level to obtain buy-in from key stakeholders
- STEP 2** Establish a working group at local municipality level to guide and oversee the implementation process
- STEP 3** Conduct training to empower the working group
- STEP 4** Conduct a baseline survey, and develop an activity plan based on results of the survey
- STEP 5** Implement planned activities by the working group
- STEP 6** Monitor and evaluate in collaboration with three spheres of government and DPOs, following which the working group members continue the discussion and activities based on the results of monitoring and evaluation.

### 7.1.3 DEM activity examples

Activities will be implemented based on the activity plan to address barriers faced by persons with disabilities. A number of people bring up problems regarding lack of awareness, accessibility and empowerment. To address these problems, three activities are shown as examples: peer counselling, disability awareness activity and access audit.

## Peer counselling

### Activities example: Peer counselling



**Objective:** Persons with disabilities listen to one another and share challenges and experiences to enhance their self-confidence, self-esteem and self-representation.

Peer counselling is one of main activities for the empowerment of persons with disabilities. Persons with disabilities listen to one another as peers and share challenges and experiences to enhance their self-confidence, self-esteem and self-representation.

To start peer counselling, firstly Peer Counsellor Training is conducted for three days essentially for persons with disabilities who have the potential to become peer counsellors.

## Disability awareness activities

### Activities example: Disability awareness activity



**Objective:**  
Promote understanding of the social model of disability.

**Social model:**  
Environment (society) makes a person disabled.  
Disability is NOT within a person.

The social model of disability is a key perspective to promote disability mainstreaming. The social model recognises that 'the environment makes a person disabled'. That is why we need to promote disability mainstreaming.

Persons with disabilities facilitate the disability awareness activity. In the activity, facilitators with disabilities share their experiences of disability from the social

model perspective, such as experience of discrimination. The participants discover what disability is from the social model perspective through dialogue with facilitators with disabilities.

Disability Awareness Facilitator Training is conducted for three days essentially for persons with disabilities who have the potential to become the facilitators.

## Access audit

### Activities example: Access audit

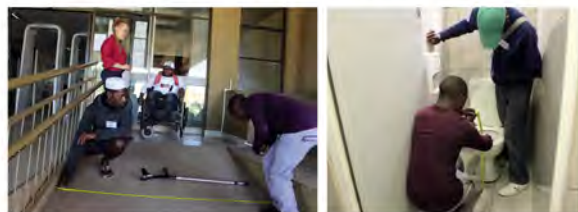

**Objective:**  
To examine the accessibility and 'usability' of facilities and services.

Accessibility deals not only with physical barriers but also informational and attitudinal barriers.

An access audit examines the accessibility and usability of facilities and services (for various barriers such as physical, information, communication and attitudinal barriers).

An access audit is led by access auditors who have received training in access auditing over three days.

Persons with various types of impairments are recommended to be the auditors so

that they can audit accessibility from the perspectives of users of facilities and services.

Access Auditor Training is conducted for three days essentially for persons with disabilities and relevant stakeholders who have the potential to become the access auditors.



### Other activities for mainstreaming

For disability mainstreaming, disability perspective should be considered in existing programmes so that persons with disabilities can participate in the existing community programmes such as Community Work Programme (CWP), learnerships, Extended Public Work Programme (EPWP), etc.

Cooperation with municipal stakeholders such as councillors and community programme officials is encouraged since they work closely with communities. In addition, collaboration with existing events and networks such as the Disability Forum in municipalities is also effective and efficient towards promoting the DEM approach in communities (For further examples of the activities, refer to Step 5: Implement planned activities in Part 3, and Part 5: Good practice case studies).

#### 7.1.4 Social model of disability (recap of disability awareness activity)

The DEM approach is based on the social model of disability, which is a key perspective to promote empowerment of persons with disabilities and disability mainstreaming. The social model sees disability as a social construct, with disability arising not from individuals, but from a social environment where diversity is not respected. Therefore, the approach looks at ways of removing barriers that restrict the life choices of persons with disabilities.



The working group should participate in disability awareness activity before the DEM introductory workshop to understand social model of disability. Disability awareness activity is conducted by trained working group members with disabilities.

(For content and presentation of disability awareness activity, refer to Tool 5: Facilitation guide on Disability Awareness Facilitator Training, and Tool 6: Presentation on disability awareness activity.)

### 7.2 Report on results of the baseline survey

This session aims at achieving a common understanding of the current status, needs and barriers of persons with disabilities in the implementation site in order to develop activity plans. The participants become aware of several strong barriers identified to be addressed through the results of the baseline survey.

The report should be presented by a person who has analysed the results of the baseline survey. It might be a district disability coordinator or area social workers. An example of the report is presented in Tool 8.



### 7.3 Presentation on the activity plan template

The participants utilise a template to develop an activity plan. The template is helpful in implementing the project confidently and smoothly. It is recommended that this template is combined with a monitoring template. The proposed template items are:

- Objective
- Planned activities
- Targets
- Timeframe
- Costing or budget items
- Responsible persons
- Progress (populate when monitoring is conducted)
- Reason for deviation (populate when monitoring is conducted)
- Corrective action (populate after monitoring is conducted.)

**TOOL 11** ACTIVITY PLAN AND MONITORING TEMPLATE

Project site (province, district, local municipality):  
 Date:  
 Problem statement:  
 Objective:

PLANNED ACTIVITIES	TARGETS	TIMEFRAME	COSTING OR BUDGET ITEMS	RESPONSIBLE PERSONS	PROGRESS	REASON FOR DEVIATION	CORRECTIVE ACTION

The activity and monitoring template are attached as Tool 11.

The **objectives** should be stated specifically, concretely and realistically to address the identified barriers. Two examples are shown as follows:

Example 1:

	BAD EXAMPLE	GOOD EXAMPLE
<b>OBJECTIVE</b>	Disability forum has improved.	The forum members with disabilities are empowered to advocate for their rights and represent others with disabilities in community.

Example 2:

	BAD EXAMPLE	GOOD EXAMPLE
<b>OBJECTIVE</b>	The attitude of taxi drivers changed.	The taxi drivers understand the rights and needs of persons with disabilities. The drivers welcome and support any persons with disabilities when they use the taxi.



**Activities** should be specific, realistic and achievable, and undertaken towards accomplishing the objectives. They should be broken down into smaller activities in a chronological sequence, and composed of three parts, i.e. preparation; implementation and follow-up; monitoring and evaluation.

The **timeframe** and **costing/budget** should be carefully considered for feasibility and cost effectiveness. Also, appropriate budget allocation and demarcation of the budget among stakeholders should be clarified and considered.

#### **7.4 Identification of strong barriers to participation of persons with disabilities in the implementation site, and development and consolidation of activity plans**

The facilitator enables the session to go forward so that the participants identify strong barriers and needs of persons with disabilities in the implementation site based on the results of the baseline survey.

The participants develop activity plans to address those identified barriers. In order for all participants to be actively involved in the development of the activity plan, participants are recommended to divide into small groups (fewer than eight people in the group taking into consideration a balance of persons with and without disabilities). Then in the session on presentation of activity plans, developed activity plans by each small group are shared with all participants. Lastly, the facilitator invites all participants to discuss, consolidate and finalise the activity plan. Before closing the workshop, the next actions, along with a concrete time schedule, should be confirmed by the participants (an example of the developed activity plan is attached as Tool 12).



This working group develops an activity plan in a group to improve accessibility of information (Limpopo)





## REFERENCES

Department of Social Development, RSA. 2012. Disability Mainstreaming Implementation Toolkit.

Department of Social Development, RSA. 2015. White Paper on the Rights of Persons with Disabilities. <https://www.gov.za/documents/white-paper-rights-persons-disabilities-official-publication-and-gazetting-white-paper>

Kuno, K. 2012. *Doing Disability Equality Training*. Kuala Lumpur: MPH Publishing (DET Manual No. 6). <http://detforum.com/intl/wp-content/uploads/2009/03/Doing-Disability-Equality-Training.pdf>



Persons with disabilities and government officials develop an activity plan together (Limpopo)



**TOOL 10**

# DEM Introductory Workshop

Building a Caring Society. Together.

[www.dsd.gov.za](http://www.dsd.gov.za)



## Concept of Empowerment of Persons with Disabilities and Disability Mainstreaming (DEM) approach

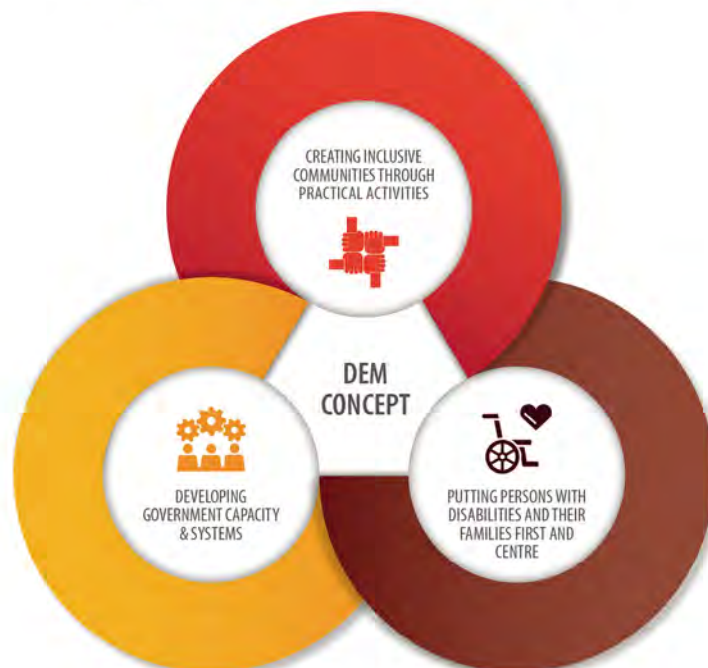

2



# DEM Implementation Steps

**STEP 1** (PG 17)  
Create a platform at district level to obtain buy-in from key stakeholders

**Step 1:** Create a platform at district level to obtain buy-in from key stakeholders

**STEP 2** (PG 18)  
Establish a working group at local municipality level to guide and oversee the implementation process

**Step 2:** Establish a working group at local municipality level to guide and oversee the implementation process

**STEP 3** (PG 20)  
Conduct training to empower the working group

**Step 3:** Conduct training to empower the working group

**STEP 4** (PG 26)  
Conduct a baseline survey and develop an activity plan based on results of the survey

**Step 4:** Conduct a baseline survey, and develop an activity plan based on results of the survey

**STEP 5** (PG 31)  
Implement planned activities by the working group

**Step 5:** Implement planned activities by the working group

**STEP 6** (PG 36)  
Monitor and evaluate in collaboration with three spheres of government and DPOs

**Step 6:** Monitor and evaluate in collaboration with three spheres of government and DPOs



3

## Activities example: Peer counselling



**Objective:** Persons with disabilities listen to one another and share challenges and experiences to enhance their self-confidence, self-esteem and self-representation.

4



## Activities example: **Disability awareness activity**



### **Objective:**

Promote understanding of the social model of disability.

### **Social model:**

Environment (society) makes a person disabled.

Disability is NOT within a person.

5

## Activities example: **Access audit**



### **Objective:**

To examine the accessibility and 'usability' of facilities and services.

Accessibility deals not only with physical barriers but also informational and attitudinal barriers.

6

# Social Model of Disability

## - Disability Awareness Activity -



Refer to Tools 5 and 6

7

Source for graphic: © Kuno, JICA, DET Forum



# Report on results of the baseline survey

## - Questionnaire survey -

SECTION A: IDENTIFICATION AND BACKGROUND INFORMATION	
A1	Address: (Only the name of municipality, ward and village) Municipality: Ward: Village:
A2	Contact telephone number
A3	Gender 1. <input type="checkbox"/> Female 2. <input type="checkbox"/> Male
A4	Age ( ) years
A5	Current status 1. <input type="checkbox"/> Student, specify ( ) 2. <input type="checkbox"/> Working, specify occupation ( ) 3. <input type="checkbox"/> Stay at home, specify ( ) 4. <input type="checkbox"/> Other, specify ( )
A6	What is your impairment/disability? (Multiple answers allowed) 1. <input type="checkbox"/> Visual 2. <input type="checkbox"/> Hearing 3. <input type="checkbox"/> Physical 4. <input type="checkbox"/> Intellectual/psychosocial 5. <input type="checkbox"/> Other, specify ( )
SECTION B: ACCESSIBILITY	
Relevance to the WPRPD: Pillar 1 – Removing Barriers to Access and Participation Focus Area: Access to the built environment	
B1	What facilities do you want to improve accessibility? (Multiple answers allowed) 1. <input type="checkbox"/> Housing (e.g. own, relative's, friend's, neighbour's) 2. <input type="checkbox"/> Healthcare facilities (e.g. clinic, hospital, rehabilitation centre) 3. <input type="checkbox"/> Education facilities (e.g. school, college, university) 4. <input type="checkbox"/> Workplaces 5. <input type="checkbox"/> Markets and shops 6. <input type="checkbox"/> Public/community facilities (e.g. local government offices, church/mosque/temple, community centre) 7. <input type="checkbox"/> Other, specify ( )

8



## (Example) Results from the questionnaire survey

### Respondents

32 persons with disabilities in xx villages took part in questionnaire survey.

**Gender:** 19 females and 13 males

**Average age:** 36 years

**Current status:** 77% of respondents said they stay at home; 5% of respondents are students

<b>Impairments:</b> Physical	70% (23)
Visual	20% (6)
Intellectual/Psychosocial	7% (2)
Hearing	3% (1)
Others	0% (0)

9

## (Example) Strong barriers based on the results of the questionnaire survey

1. Participants experience challenges with **infrastructure** especially in **public/community facilities**.
2. **Transport** is also identified as one of the challenges as the transport mode and system are not disability friendly.
3. Those members with visual impairments experience challenges with **accessing information** as it is written in small type.
4. In respect of education, participants expressed challenges of **teachers having inadequate skills** to meet their needs on impairment.

10





## Tips for development of an activity plan

### Objective:

- Brief statement of the goal to be achieved
- Aims to address the identified barriers based on results of the baseline survey

### Activities:

- Should be specific, realistic and achievable, and undertaken towards accomplishing the objectives
- Should be broken down into smaller activities in a chronological sequence, and composed of three parts (i.e. preparation, implementation, monitoring)

### Timeframe and costing/budget:

- Should be carefully considered with feasibility and cost-effectiveness
- Appropriate budget allocation and demarcation of the budget among stakeholders should be clarified and considered.

13

## Development and consolidation of activity plans

1. **Identify strong barriers** and needs based on the results of the baseline survey
2. **Develop activity plans** to address the identified barriers
3. **Divide into small groups** so all participants could be actively involved
4. Developed activity plans from each small group are **shared with all participants**
5. All participants discuss, **consolidate and finalise** the activity plan.

14





Persons with disabilities and government officials assess accessibility at a SASSA office (Free State)









## TOOL 12

### EXAMPLE OF A DEVELOPED ACTIVITY PLAN

Project site (province, district, local municipality):

Date:

Problem statement: People with disabilities are unable to access health services

Objective: To strengthen working relations between the working group (WG) and Department of Health (DOH)

PLANNED ACTIVITIES	TARGETS	TIMEFRAME	COSTING OR BUDGET ITEMS
Community dialogues: Compiling of report on outcomes of the dialogues	Community members Community leaders	xx Jul	Transport
Meeting with DOH, management for the introduction of the WG	DOH managers Board members Managers of health facilities	xx Aug	Transport
Disability Awareness Facilitator Training	WG members with disabilities		Transport Catering
Disability awareness workshop for health workers in xx hospital	Persons with disabilities and health workers in xx hospital	xx Jul	Transport
Access Auditor Training	WG		Transport Catering
Access audit in xx hospital	Managers of health facilities		Transport
Peer Counsellor Training	WG members with disabilities		Transport Catering
Peer counselling for persons with disabilities in xx hospital	Persons with disabilities in ward 1, 2, 3	xx Jul	Transport Catering
Report on the outcomes of activities	WG, DOH, DSD Stakeholders in xx hospital	xx Aug	Telephone
Follow up and monitoring monthly	Staff in xx hospital	Aug–Nov	Transport
Develop a new activity plan based on the results of baseline survey	WG	Aug–Nov	Transport
Continue the planned activities	xx community	Nov	Transport



	RESPONSIBLE PERSONS	PROGRESS	REASON FOR DEVIATION	CORRECTIVE ACTION
	Ms xx, DOH Mr xx, DSD			
	Ms xx, DOH Mr xx, DSD			
	Mr xx, DSD			
	Ms xx, DOH Mr xx, DSD			
	Ms xx, DSD Mr xx, DPS			
	Ms xx, DOH Mr xx, DPW			
	Ms xx, DSD Mr xx, WG			
	Ms xx, DOH Mr xx, DSD			
	Mr xx, WG			
	Mr xx, DSD Mr xx, WG			
	Ms xx, WG			
	WG			



## TOOL 13

### FACILITATION GUIDE ON ACCESS AUDITOR TRAINING

#### 1 BACKGROUND

---

An access audit examines the accessibility and 'usability' of facilities and services for various barriers such as physical, information, communication and attitudinal barriers. The access audit identifies barriers and considers the means of eliminating or mitigating them. The access audit is led by access auditors who are specially trained in the training programme. Persons with various types of impairment are recommended to become auditors so that they can audit accessibility from the varied perspectives of users of facilities and services.

#### 2 OBJECTIVES OF THE TRAINING

---

- To understand the requirements of the legislative framework of South Africa, such as the White Paper on the Rights of Persons with Disabilities (WPRPD), and Part S of the South African National Standards (SANS) 10400
- To understand accessibility of facilities and services for persons with disabilities
- To obtain knowledge and skills to conduct access audits through practice.

#### 3 TARGET PARTICIPANTS

---

- Potential leaders with various types of impairment in the implementation site
- Stakeholders such as officials of DSD, Department of Public Works, and municipalities
- The number of participants is recommended to be fewer than 30 persons for well-managed training and achieving the objectives.

#### 4 RECOMMENDED ORGANISERS AND DEMARCATION

---

The organisers are drawn from district DSD and municipalities in collaboration with provincial DSD and the working group. The recommended demarcation is as follows:

- a) District DSD and municipalities in collaboration with provincial DSD and the working group
  - Nomination of participants
  - Arrangement of accessible venue, transport for participants, and catering.
  - Communication and coordination with a trainer
  - Dispatch of trainer(s) (in consultation with national DSD if needs arises)

b) Trainer(s)

- Development of programme and materials
- Facilitation of the training
- Development and submission of report on the training to the organisers

## 5 EQUIPMENT AND MATERIALS REQUIRED



The following equipment and materials are required for Access Auditor Training:

- Paper and pens
- Measuring tape
- Checklist, simplified ramp gradient finder, and template of recommendation report (refer to 7.7 Access Audit on page 149)
- Laptop, projector and screen

## 6 PROGRAMME EXAMPLE

The length of workshop should be three days to achieve the training purposes. An example of a programme for three days is as follows:



DAY 	TIME 	ITEM 
DAY 1	09:00–09:30	Welcome and introductions
	09:30–10:00	Purpose and background
	10:00–10:30	WPRPD and accessibility <ul style="list-style-type: none"><li>• Outline of six focus areas of accessibility</li></ul>
	10:30–12:00	Six focus areas of accessibility (part 1) <ul style="list-style-type: none"><li>• Changing attitudes and behaviour</li><li>• Universal access and design</li><li>• Reasonable accommodation</li></ul>
	12:00–13:00	Lunch break
	13:00–15:30	Six focus areas of accessibility (part 2) <ul style="list-style-type: none"><li>• Access to information and communication</li><li>• Access to transport</li><li>• Access to the built environment</li></ul>
	15:30–16:00	Q & A

DAY 	TIME 	ITEM 
DAY 2	09:30–10:00	Recap of Day 1 of the workshop
	09:30–11:00	What is an access audit? <ul style="list-style-type: none"> <li>• Access audit checklist</li> <li>• Develop recommendation report</li> </ul>
	11:00–13:00	Access audit practice at a training venue <ul style="list-style-type: none"> <li>• Utilising a checklist and recommendation report template</li> </ul>
	13:00–14:00	Lunch break
	14:00–15:00	Presentation of the findings of access audit to responsible persons of a training venue
	15:30–16:00	Preparation for access audit practice on Day 3 <ul style="list-style-type: none"> <li>• Confirm access audit members, access audit route and points</li> </ul>
	15:30–16:30	Q & A
DAY 3	09:00–09:30	Recap of Day 2 of the workshop
	09:30–11:30	Access audit practice at public institutions (e.g. municipality, SASSA)
	11:30–12:00	Presentation of findings of access audit to responsible persons
	12:00–13:00	Development of next access audit plan
	13:00–	Way forward and closing

## 7 TRAINING CONTENT

The programme content is aligned with the WPRPD and SANS 10400. The programme has the following components:

- Why does accessibility need to be improved? (Legislative framework)
- Six focus areas of accessibility in the WPRPD:
  - Changing attitudes and behaviour
  - Access to the built environment
  - Access to transport
  - Access to information and communication
  - Universal design and access
  - Reasonable accommodation measures
- Overview of access audit
- Access audit practice.



## 7.1 Why does accessibility need to be improved? (Legislative framework)

The WPRPD is built on nine strategic pillars for realising the rights of persons with disabilities:

- Strategic Pillar 1: Removing Barriers to Access and Participation
- Strategic Pillar 2: Protecting the Rights of Persons at Risk of Compounded Marginalisation
- Strategic Pillar 3: Supporting Sustainable Integrated Community Life
- Strategic Pillar 4: Promoting and Supporting the Empowerment of Children, Women, Youth and Persons with Disabilities
- Strategic Pillar 5: Reducing Economic Vulnerability and Releasing Human Capital
- Strategic Pillar 6: Strengthening the Representative Voice of Persons with Disabilities
- Strategic Pillar 7: Building a Disability Equitable State Machinery
- Strategic Pillar 8: Promoting International Co-operation
- Strategic Pillar 9: Monitoring and Evaluation.

Pillar 1 of the WPRPD is specified as 'Removing Barriers to Access and Participation'. Pillar 1 also states: "Accessibility lies at the heart of the right to human dignity – being able to live as an equal resident in one's community, being accorded respect for your personal space, having the right to equal opportunities and negotiating one's life unhindered by man-made barriers".

The WPRPD highlights the six dimensions that have to be addressed in order to remove barriers to access and participation: Changing attitudes and behaviour; Access to the built environment; Access to transport; Access to information and communication; Universal design and access; and Reasonable accommodation measures.



## 7.2 Focus areas of accessibility in the WPRPD: Changing attitudes and behaviour

Anything wrong here?



(Source for the slide: DET Forum)

The slide shows a woman using a wheelchair and her personal assistant who are visiting a shop and being helped by a salesperson. The wheelchair user is indicating to the salesperson a shirt that she wants. But the salesperson ignores her and addresses her personal assistant, "So, what is her size?"

A facilitator asks participants, "Anything wrong here?" In answering this question, participants will realise how attitudinal and behavioural barriers are present in the lives of persons with disabilities.

The WPRPD says: "Harmful and negative attitudes and stereotypes associated with disability continue to segregate persons with disabilities from mainstream social and economic life".

UNCRPD recognises that "disability results from the interaction between persons with impairments and attitudinal and environmental barriers that hinders their full and effective participation in society on an equal basis with others".

## 7.3 Focus areas of accessibility in the WPRPD: Universal design and access

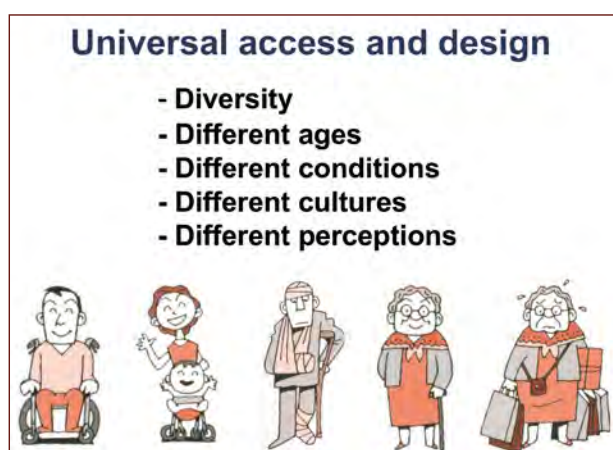

(Source for graphic: Kenichiro Miyairi & Yoshie Yokoo. 2007. Book of Universal Design.)

Universal design means the design of products, environments, programmes and services to be usable to the greatest extent possible by everyone. The WPRPD specifies that “Universal access is the ability of users to have equal opportunity and access to services, products, systems and environments; regardless of their social and/or economic situation, religious or cultural background, gender or functional limitation”.

### How to solve the problem?

The slide shows a challenging situation, i.e. a boy using a wheelchair enrolls at a primary school in his community. He cannot participate in class activities because his class is located on the second floor.

*The facilitator asks the participants how to solve the problem.*

How to solve the problem?	How to solve the problem?
<p>A boy using wheelchair enrolls at a primary school in his community.</p> <p>He cannot participate in class activities because his class is located on the second floor.</p> <p><b>As a community or a principal, what can we do to solve this problem?</b></p> 	<ul style="list-style-type: none"> <li>Refuse to enrol the boy at the school</li> <li>Suggest a special school, without consultation with the boy and his family</li> </ul> <p>No equal basis with others/No freedom of choice <b>Attitudinal Barriers</b></p> <ul style="list-style-type: none"> <li>Install a ramp at the school</li> <li>Change the classroom to the ground floor</li> </ul> <p><b>Reasonable Accommodation</b></p> <ul style="list-style-type: none"> <li>Install a lift at the school</li> <li>All classrooms are located on the ground floor (= horizontal building design)</li> </ul> <p><b>Universal Design</b></p>

There are several options for solutions as follows:

**Option 1:** Refuse to enrol the boy at the school.

**Option 2:** Suggest a special school without consultation with the boy and his family.

**Option 3:** Install a wheelchair-accessible ramp at the school.

**Option 4:** Change the classroom to the ground floor.

**Option 5:** Install a lift at the school.

**Option 6:** Locate all classrooms on the ground floor (horizontal building design).

Options 1 and 2 are not on an equal basis with others, and give no freedom of choice: This is an example of attitudinal barriers. Options 3 and 4 represent the provision of reasonable accommodation. Options 5 and 6 show universal design solutions.

## 7.4 Focus areas of accessibility in the WRPDP: Access to information and communication

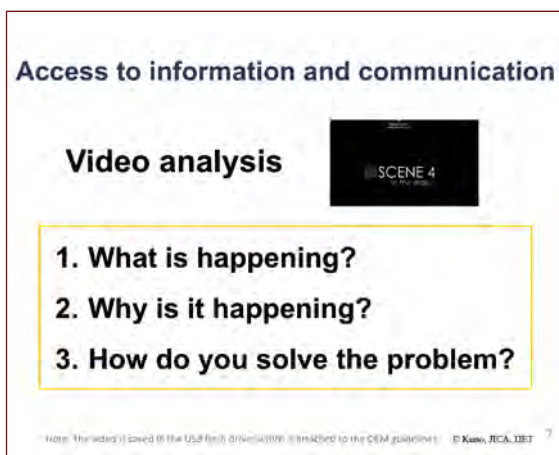

(Source for the video: DET Forum)

After the presentations, the participants watch another video which shows how to resolve each situation.

(The video is saved in the USB flash drive which is attached to the DEM guidelines.)

### Video analysis

Participants watch several scenes in a short video which show persons with various types of impairment having trouble with access to information and communication. They face challenges with participating in getting information and access to communication.

Participants discuss and share their answers on **what** is happening, **why** it happens, and **how** to resolve the situation.

After the presentations, the participants watch another video which shows how to resolve each situation.



**Deaf persons:** Often require access to South African Sign Language (SASL) as their first language. They may also require access to SASL interpreters, as well as note-takers, captioning and texting to facilitate access to information and communication.

**Persons with hearing impairments and/or those who acquire deafness later in life:** They might never have utilised SASL as their language of choice. They may require access to lip readers, note-takers, loop systems, captioning and texting for access to information and communication.



### EFFECTIVE COMMUNICATION WITH PERSONS WITH HEARING IMPAIRMENTS

- Get the person's attention by moving into their line of vision or giving a small wave
- Make sure that the person sees you before you begin the conversation (establish eye contact)
- Ask how you can communicate with the person (sign language, note-taking, cellphone text, etc.)
- Speak clearly so the person can see and read your lips.



## Persons with visual impairments

Text to be made available in alternative formats such as **Braille, large print, descriptions of graphs and pictures, as well as in audio format**



WPRPD (2015) 9

**Persons with visual impairments:** They often require that text be made available in alternative formats such as Braille, large print, descriptions of graphs and pictures, as well as in audio format.

Braille is a tactile script used by blind people to read and write by feeling raised bumps.

*(Note: Not all persons with visual impairments use Braille.)*



## EFFECTIVE COMMUNICATION WITH PERSONS WITH VISUAL IMPAIRMENTS

- When approaching a person, speak to them so that they know someone is approaching
- Identify yourself to be recognised, e.g. 'It's Bonita', or 'My name is Micah'
- Ask how you can help by saying, 'How can I assist you?' or 'May I offer you an arm?'
- Prepare Braille documents or soft data but if not available, read out the information.

## Persons with speech impairments

- **Ask the person again clearly and gently when you cannot understand them. (Avoid pretending you understand)**
- **Use alternative and augmentative communication to communicate and access information.**

WPRPD (2015)



10

**Persons with speech impairments:** Various factors can cause speech difficulties and language problems. Therefore do not assume that because a person has a speech difficulty, they have a learning difficulty or an intellectual impairment. For effective communication, you can ask the person again clearly and gently when you cannot understand them. Avoid pretending you understand.

Persons with speech impairments often require alternative and augmentative communication to communicate and access information.



## EFFECTIVE COMMUNICATION WITH PERSONS WITH SPEECH IMPAIRMENTS

- Patience is important, so show this in your voice and tone
- Do not correct the person or finish their sentences
- Ask one question at a time
- If you don't understand the person, ask them to repeat what they have just said
- Ensure that you know what they have said by repeating what you understand, and ask if this is correct.



## Persons with intellectual impairments

Need **human support to meet their needs** and required **tailored and innovative information and communication interventions and support services, such as easy-to-read materials.**

WPRPD (2015)



Picture card



Photo



Gesture

**Persons with intellectual impairments:** Persons with intellectual disabilities require human support to meet their needs. They also need tailored and innovative information and communication interventions and support services such as easy-to-read materials.

Communication boards or picture cards are panels or signs with symbols or pictures that are used to facilitate communication. The communication board is one means of non-

verbal communication. Adults and children communicate using the board by pointing at the symbols and pictures.



## EFFECTIVE COMMUNICATION WITH PERSONS WITH INTELLECTUAL IMPAIRMENTS

- Communicate with the person as if they are any other person
- Don't hold any prejudices about what you think they will or won't understand
- A patient attitude is important
- Use simple words and keep your conversation clear and straightforward
- If necessary, use various communication methods such as gestures or pictures.



## 7.5 Focus areas of accessibility in the WPRPD: Access to transport

The WPRPD emphasises that “inaccessible public and private systems across the travel value chain are a major barrier to the right to equality for persons with disabilities. Adequate, efficient, safe and accessible transport is required to support productivity and assist South Africans to access basic services, especially in impoverished and rural communities. The ability to move around the community underpins all aspects of life for persons with disabilities to access the general enjoyment of rights including learning and employment”.



### TIPS FOR PERSONS WITH DISABILITIES TO CHANGE ATTITUDE AND BEHAVIOUR OF TAXI DRIVERS

- Communicate with the driver and express yourself clearly
- Explain what kind of support you need
- Create a good relationship with drivers (don't complain or make demands but instead appreciate their support)
- If it is difficult to change attitudes and behaviour, consult with officials of the Department of Transport and the taxi association (e.g. Southern African National Taxi Council [SANTACO]) as a working group.



## Voice of persons with disabilities

(Watch a video)



Note: The video is saved in the USB flash drives which is attached to the DEM guidelines.

13

### WATCH A VIDEO CLIP:

#### Voice of persons with disabilities

In the video (3 minutes), a wheelchair-user shares his experience of building good relationships with taxi drivers and improving his access to taxis as a means of transport.

*(The video is saved on the USB flash drives which are attached to the DEM guidelines)*

The WRRPD describes how all transport-related licences and permits for all modes of transport must include universal access and design requirements.

The WRRPD also stipulates the importance of an access audit. It says that all public and private transport operators must conduct operational, staff and managerial audits of existing infrastructure, fleet and programmes against legislated minimum norms and standards. A quantified and costed plan must be developed to implement the outcomes of the access audit. Implementation of the plan must be budgeted for.

## Wheelchair-accessible van (with a ramp or powered lift)



## 7.6 Focus areas of accessibility in the WRRPD: Access to the built environment



### South African National Standards (SANS) 10400-S

The National Building Regulations and Building Standards Act, 1977, as well as the National Guidelines for Accessibility currently constitute the regulatory framework for accessibility to the built environment. For any building used by the public to conform to the requirements of the National Building Regulations, its facilities must meet the standards and measurements contained in the SANS 10400-S document published in 2011.

SANS 10400-S is the part of SANS 10400 that provides deemed-to-satisfy requirements for compliance with part S (Facilities for Persons with Disabilities) of the National Building Regulations.

## Requirements: SANS 10400-S

- General
- Signage
- Parking
- External and internal circulation
- Floor or ground surfaces
- Doorways, doors and door handles
- Changes in level
- Ramps
- Stairways
- Handrails
- Lifts
- Toilet facilities
- Auditoriums, grandstands and halls
- Controls, switches and power points
- Warning signals
- Lighting

There are 16 specified requirements in the SANS 10400-S.

Some requirements are highlighted in the training, including signage, parking, external and internal circulation, ramps, stairways, handrails and toilet facilities.

### Minimum mobility space for wheelchair

The minimum mobility space is: length 120 cm and width 90 cm. Therefore the width of entrances and walking surfaces should be more than 90 cm.

*(Note: Space allowances in this part should accommodate the use of self-propelled wheelchairs. The minimum dimensions might need to be increased to accommodate the full range of different types of wheelchair.)*

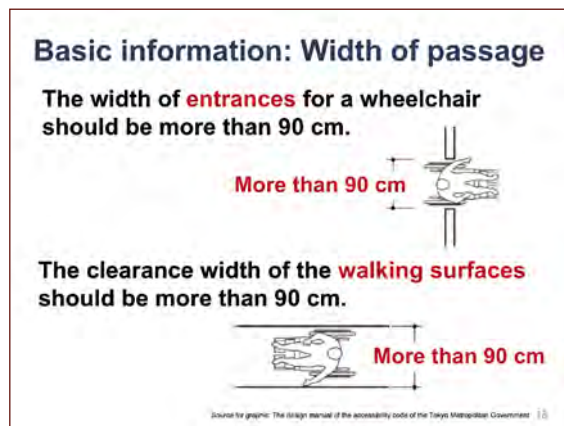
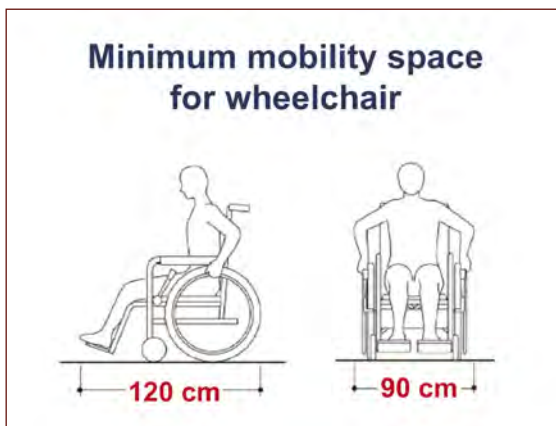

Source for graphic: The design manual of the accessibility code of the Tokyo Metropolitan Government



### Signage

Facilities that are included in a building specifically for use by persons with disabilities, such as wheelchair-accessible parking spaces, wheelchair-accessible toilets, and platform or stair lifts, should be indicated by the appropriate signage.

The signage should be:

- Well located to be easily visible
- Adequate size and type of font to be read easily
- Contrasting light and dark colours
- Clear information.

## Accessible signage for persons with visual impairments

**Accessible signage for persons with visual impairment**

To enable persons with low vision to read location signage next to doors or directional signage on walls, the signs should be placed at a height between 1.4 – 1.7 m above finished floor level.

Signs should be in clear, visible and tactile format to ensure that persons with visual impairments are also fully informed.

To enable persons with low vision to read location signage adjacent to doors or directional signage on walls, the signs should be placed at a height of between 1.4–1.7 m above finished floor level.

**Accessible signage for persons with visual impairment**

Hanging signs must have a clearance of more than 2 m above the trafficable surface.

Hanging signs should have a clearance of more than 2 m above the trafficable surface

**Accessible signage for persons with low vision**

**Enlarge letters**

A → **A**

**Brightness and contrast**

**A**   **A**

- Raised letters and symbols, in contrasting light and dark colours, on identification or location signs, assist those persons with low vision
- The height of the lettering should not be less than 50 mm.

## External and internal circulation

**External and internal circulation**

- **At least one accessible route** should be provided from accessible parking spaces and public streets to the building entrance, and to the facilities inside the building.
- Accessible routes should be considered among the road, parking, entrance, toilet, ramp, lift and rooms.

- At least one accessible route should be provided from accessible parking spaces and public streets to the building entrance which they serve, and to the facilities inside the building
- Accessible routes should also be considered among the road, parking, entrance, toilet, ramp, lift and rooms
- The clear width of the walking surfaces should not be less than 90 cm and should not be reduced or obstructed by protruding objects.

Source for graphic: The design manual of the accessibility code of the Tokyo Metropolitan Government





### EXAMPLE: a route from parking to an entrance of a hotel

There is no step-free access at the entrance even though the sign indicates that it is wheelchair accessible.

### Obstructions in the path of travel

#### External and internal circulation: Obstructions in the path of travel

Wall-mounted fire extinguishers, hose reels, telephones, litter bins and any other wall-mounted fittings should:

- be designed to be **seen easily**
- be shielded or recessed to **prevent injuries**.

- Windows and doors should not open across a walkway, corridor, stair or ramp. Doorstops must be so positioned that any door will open to its maximum, to ensure that it will not create a hazard.
- Wall-mounted fire extinguishers, hose reels, telephones, litter bins and any other wall-mounted fittings should:
  - a) be designed to be easily seen
  - b) be shielded or recessed to prevent injuries.



### Parking

#### Parking

Accessible parking spaces:

- Length: Not less than **4.5 – 5 m**
- Width: Not less than **3.5 m**
- **Located within 50 m** of an accessible entrance

- For employee parking, at least one parking space should be accessible for persons with disabilities
- Any parking space provided for vehicles used by persons with disabilities should be clearly demarcated as being intended for the use of persons with disabilities only
- Any parking space provided for vehicles used by persons with disabilities should be located within 50 m of an accessible entrance
- Accessible parking spaces: Length must not be less than 4.5–5 m; and width not less than 3.5 m.

**EXAMPLE:** The parking space shown in the picture is not accessible for wheelchair users. The facilitator asks the participants whether the parking is accessible for wheelchair users, and facilitates the participants' responses to the following points:



The parking is not accessible for the following reasons:

- There is an accessible parking space near the entrance but there is a step to enter the entrance
- The accessible entrance is located far away (more than 50 m) from the parking space (to the left and not seen in the picture)
- The width of parking space is not enough space (less than 3.5 m).

## Ramp



Source for graphic: The design manual of the accessibility code of the Tokyo Metropolitan Government

Any ramp or series of ramps should provide a safe, comfortable and convenient route for wheelchair users. Any ramp provided in terms of this part of SANS 10400 must:

- Have a gradient, measured along the centre line, that is not steeper than 1:12
- Have a clear, trafficable surface not less than 1.1 m wide
- Have a surface which is stable, firm and slip-resistant
- Have a landing at the top and bottom of each ramp of not less than 1.2 m in length and a width not less than that of the ramp
- Have a handrail on both sides of the ramp.

## Using a ramp gradient finder

A ramp gradient finder is used to find out whether a ramp has the appropriate gradient that is not steeper than 1:12. The finder can be made simply by yourself with paper, cardboard, string, a coin, etc.

For instructions on how to make and use the ramp gradient finder, refer to Tool 15: Materials for access audit.

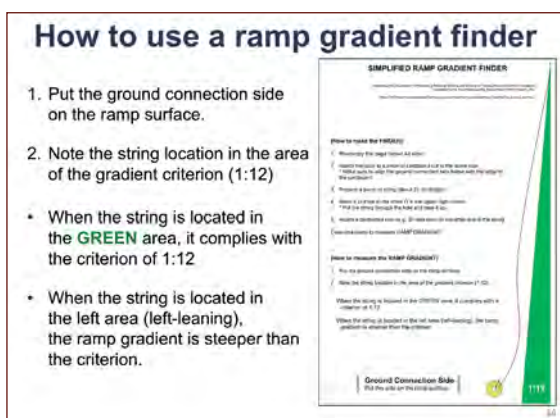



## Stairways

**Stairways**

- Must be have **handrails on both sides** of the stairway
- **Contrast:** The edges of the treads must be delineated by a contrasting colour, i.e. different from the colour of the remainder of the treads.
- **Length:** More than 90 cm
- **Height:** Less than 17 cm
- **Width:** More than 28cm

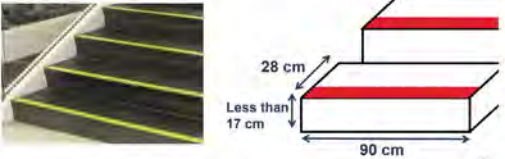

- The width of any stairway, measured to an enclosing wall or balustrade, should be at least 90 cm
- The riser of each tread step should be the same height and must not exceed 17 cm
- A stairway should be equipped with handrails on both sides of the stairway.

## Handrails

**Handrail**

- Handrail provided on both sides
- **Height:** Top of a handrail from the surface of a ramp should be in range 90 cm to 1 m



- The height to the top of a handrail from the nosing of the tread of the stairs or from the surface of a ramp should be in the range 90 cm to 1 m, and must remain consistent along the length.



## Wheelchair-accessible toilets

**Is this toilet accessible for wheelchair users?**



In any building with facilities for persons with disabilities, there should be one or more toilets or unisex toilet facilities suitable for use by wheelchair users.

**Example: The toilet shown in the picture is not accessible for wheelchair users.**

*The facilitator asks the participants whether the parking is accessible for wheelchair users, and facilitates the participants' responses to the following points:*

The door does not open outwards, and there is not enough space in the compartment for wheelchair users. A wheelchair user cannot close the door after he/she enters the compartment.

### Wheelchair-accessible toilet: Door

- Should open outwards
- Have a clear opening of more than 90 cm

90 cm  
Open outwards

Source for graphic: The design manual of the accessibility code of the Tokyo Metropolitan Government 39

Source for graphic: The design manual of the accessibility code of the Tokyo Metropolitan Government

The doors into accessible toilets should open outwards and have a clearance opening of 90 cm.

### Wheelchair-accessible toilet: Space

Minimum wall-to-wall dimensions of the toilet should be more than 1.8 m x 1.8 m.

More than 1.8 m  
More than 1.8 m  
1.8 m

Check whether the toilet compartment has enough space for maneuvering

Source for graphic: The design manual of the accessibility code of the Tokyo Metropolitan Government 40

Source for graphic: The design manual of the accessibility code of the Tokyo Metropolitan Government

The minimum finished wall-to-wall dimensions of the compartment should be not less than 1.8 m x 1.8 m so a wheelchair can turn through 360°.

To enable transfer from a wheelchair to the toilet seat, there must be sufficient space next to the toilet bowl.

48 - 50 cm

Source for graphic: The design manual of the accessibility code of the Tokyo Metropolitan Government

The top surface of the seat of the toilet should not be less than 48 cm or more than 50 cm above the floor level.

*The facilitator asks the participants why this particular height is needed.*

*Answer: It is needed for a wheelchair user to transfer smoothly to or from the seat.*

### Wheelchair-accessible toilet: Grab rails

- Suitable grab rails should be fixed to the side wall and the rear wall.
- The height of the grab rail is 74 cm (between the grab rail and floor level).
- The centre line of the toilet should be in the range 45-50 cm from the nearside wall.

40 - 50 cm  
74 cm

44

A distance of not less than 45 cm and not more than 50 cm should be provided between the centre line of the toilet and the nearside wall of the toilet compartment. Suitable grab rails should be fixed to the side wall and the rear wall. The height of the grab rail is 74 cm (between the grab rail and floor level).

## 7.7 Access audit

**MATERIALS ON ACCESS AUDITOR TRAINING:  
ACCESS AUDIT CHECKLIST**



**TOOL 15-2**

The checklist was developed by the DSD/JICA project for the purpose of monitoring accessibility and usability of facilities, based mainly on the South African National Standards (SANS) 10400, the Building Regulations.







Name of facility: \_\_\_\_\_ Date: \_\_\_\_ / \_\_\_\_ / \_\_\_\_

Location of facility:  
Ward: \_\_\_\_\_ Municipality: \_\_\_\_\_

District: \_\_\_\_\_ Province: \_\_\_\_\_

Representative name of the access audit team: \_\_\_\_\_

Places of access audit:  
e.g. parking, entrance of the building, toilets, meeting room, etc.

QUESTIONS	GUIDE	YES	NO
<b>1 EXTERNAL CIRCULATION (from street to an entrance of the building)</b>			
1.1 Is the footway width more than 90 cm?		<input type="checkbox"/>	<input type="checkbox"/>
1.2 Does the route have step-free access?		<input type="checkbox"/>	<input type="checkbox"/>
1.3 Is the route clear of hazardous objects so that persons with visual impairment avoid injuring themselves, and can move easily?		<input type="checkbox"/>	<input type="checkbox"/>
<b>2 PARKING</b>			
2.1 Is there accessible parking? Size: More than 4.5 m length x 3.5 m width		<input type="checkbox"/>	<input type="checkbox"/>
2.2 Is the parking space clearly marked with both on-road symbols and vertical signs, and easy to find?		<input type="checkbox"/>	<input type="checkbox"/>
2.3 Is the parking located within 50 m of an accessible entrance?		<input type="checkbox"/>	<input type="checkbox"/>
2.4 Is there a step-free and safe route to the entrance of the building from the parking area?		<input type="checkbox"/>	<input type="checkbox"/>

### Checklist for an access audit

A checklist is a helpful tool for an access audit. Access auditors use the list to check items/facilities when they conduct the access audit. The content of the checklist is provided in Tool 15: Materials for access audit.



### What is an access audit all about?

- Examining the accessibility and 'usability' of facilities and services
- Identifying barriers and considering means of eliminating or mitigating them
- Deals not only with physical barriers but also information, legislative and attitudinal barriers.

### Access audit for whom?

- Considers accessibility and usability for persons with various types of impairment
- This consideration contributes to making facilities and services more usable by all members of society including pregnant women, older persons and children, etc.

### Access audit by whom?

Conducted as a team consisting of:

- Persons with various types of impairment (Audit from the perspective of users)
- Architects and civil engineers (Audit from the perspective of specialist)
- Government officials (e.g. DSD, Public Works) (Audit from the perspective of government)
- Stakeholders of venue/services of access audit (Audit from the perspective of owner/manager).



The implementation flow of the access audit is shown in the following seven steps:

### STEP 1: Identify needs

- What facilities and services need an access audit?
- What are the problems?
- Why have the problems happened?

### STEP 2: Obtain approval

- Communicate with the management of facilities/services to obtain approval for the access audit
- Invite DSD/municipal officials responsible for disability to the meeting with the facilities/services management.

### STEP 3: Establish access audit team

- Persons with different types of impairment
- Architects and civil engineers
- Government officials (e.g. DSD, Public Works)
- Stakeholders of venue/services of access audit.

#### STEP 4: Develop access audit plan

- Set a shared goal/objective
- Decide on focus areas of the access audit
- Design route/order and time schedule
- Allocate roles for each member (e.g. coordinator of the stakeholders, recorder, timekeeper, responsible for preparation of equipment, etc.)
- Prepare necessary equipment (e.g. checklist, pens, tape measure, simplified ramp gradient finder, SANS documents, etc.)

#### STEP 5: Conduct access audit

Conduct access audit with the checklist based on the access audit plan. The roles of the members are:

- Person with various types of impairment: Explain and demonstrate difficulties as users
- Architects and civil engineers: Explain the differences between the current situation and regulations/desirable situation as specialists (e.g. civil engineers compare the current situation with SANS)
- Government officials (e.g. DSD, Public Works): Analyse gaps between the current situations and existing policy on accessibility as government officials
- Stakeholders of venue/services of access audit: Observe access audit and take action to improve accessibility as owners.



#### STEP 6: Make a recommendation report

**Step 6: Develop a recommendation report**

ACCESS AUDIT REPORT TEMPLATE

Name: \_\_\_\_\_ Audit date: \_\_\_\_/\_\_\_\_/\_\_\_\_

Audit venue/department name: \_\_\_\_\_

URL: \_\_\_\_\_

NO.	AREA OF FACILITIES/SERVICES	CURRENT SITUATION (PROBLEMS)	RECOMMENDATION	PRIORITY	COST
1					
2					
3					
4					
5					
6					

- Areas of facilities and services
- Current situation (problems)
- Recommendations
- Priority (High/Medium/Low)
- Cost (High/Medium/Low)

59

- Make an easy-to-understand and useful report (e.g. attach recommended design with actual measurements, etc.)
- Make the report so that owners will want to improve accessibility (use polite language to encourage owners to take action)
- Submit the report to appropriate persons (e.g. owners, Public Works, municipality, etc.)

#### STEP 7: Monitoring and follow-up

- Monitoring and follow-up are recommended to be conducted within one month after submission of the report
- Monitor the progress and analyse the challenges and needs, if it has not progressed
- Take necessary actions to solve the challenges.





## TIPS FOR A GOOD ACCESS AUDIT

- Deal with attitudinal and information barriers as well as physical barriers
- Consider not only your own impairment but also various other types of impairment
- Don't be a complainer; instead be a supporter to improve facilities/services (always use polite language, work in a spirit of helping to solve a problem)
- Know the basic information on the legislative framework
- Involve persons in charge of facilities/services, from the planning to the monitoring stages
- Continually monitor and follow up to improve accessibility (an access audit is not a one-time activity).

### Access audit practice

The participants visit buildings to conduct a practical access audit (it is recommended that the buildings are public facilities near the training venue).

*Note: The training organiser needs to arrange a venue for the access audit.*

For the access audit, the following preparation is needed:

- Design a route and order
- Decide on focus areas of the access audit
- Design a time schedule
- Allocate roles for each member, such people in charge of the checklist, time management, measurement, simplified ramp gradient finder and recommendation report.

## 8 AFTER THE TRAINING: ACCESS AUDIT BY THE TRAINED ACCESS AUDITORS

The trained persons with disabilities conduct an access audit to investigate the accessibility of facilities and services at the implementation site, as well as improving their skills through practical activities. The participants in the access audit examine the accessibility and usability of facilities and services. After the access audit, they develop a recommendation report to improve facilities and services based on the results of the access audit.

It is recommended that several trained auditors conduct the access audit together as a team to assist one another. It is suggested that the team is made up of persons with various types of impairment, a civil engineer, officials of the Department of Public Works and DSD, and persons in charge of facilities and services. It is important to involve the owners/managers of facilities and services not only because they will have to give permission, but because they will be involved in any future plan to improve those facilities.

The target participants are any organisations at the implementation site such as public institutions, schools, taxi associations, shopping mall management and private companies. The length and content of the access audit should be discussed and determined by trained access auditors, the DEM working group and community stakeholders. It needs a minimum of half a day.



## REFERENCES

Department of Social Development, RSA. 2015. White Paper on the Rights of Persons with Disabilities. <https://www.gov.za/documents/white-paper-rights-persons-disabilities-official-publication-and-gazetting-white-paper>

Disability Equality Training (DET) Forum. <http://www.detforum.com/>

DET Training Video. <https://www.youtube.com/watch?v=IBfzALO7p0>

<https://www.youtube.com/watch?v=hpLrk03PCbY>

Kuno, K. 2012. *Doing Disability Equality Training: A handbook for trainers*. Kuala Lumpur, MPH Publishing. (DET Manual No. 6). <http://detforum.com/intl/wp-content/uploads/2009/03/Doing-Disability-Equality-Training.pdf>

Miyairi, K. & Yokoo, Y. 2007. *Book of Universal Design*. Japan: Nikkan Kogyo Shimbun Ltd.

QuadPara Association South Africa (QASA). n.d. Sawubona Disability. <https://qasa.co.za/sawubona-disability/>

South African Bureau of Standards (SABS). 2011. South Africa National Standards (SANS) 10400-S. [https://www.sabs.co.za/Sectors-and-Services/Services/Access/access\\_sp.asp](https://www.sabs.co.za/Sectors-and-Services/Services/Access/access_sp.asp)

Tokyo Metropolitan Government. 2020. The design manual of the accessibility code of the Tokyo Metropolitan Government . <https://www.fukushihoken.metro.tokyo.lg.jp/kiban/machizukuri/manual.html>



Persons with disabilities explain the necessary length for the ramp should be installed (Limpopo)



**TOOL 14**

# Access Auditor Training

Building a Caring Society. Together.

[www.dsd.gov.za](http://www.dsd.gov.za)



The PowerPoint slides for the Access Auditor Training were designed with reference to WPRPD, SANS 10400-S, Disability Equality Training Video, Sawubona Disability and the design manual of the accessibility code of Tokyo Metropolitan government.



## White Paper on the Rights of Persons with Disabilities

### Pillar 1: Removing Barriers to Access and Participation

#### Six focus areas of accessibility

1. Changing attitudes and behaviour
2. Access to the built environment
3. Access to transport
4. Access to information and communication
5. Universal access and design
6. Reasonable accommodation



# Anything Wrong?



© DET Forum 3



## Universal access and design

- Diversity
- Different ages
- Different conditions
- Different cultures
- Different perceptions



Source for graphic: Kenichiro Miyairi & Yoshie Yokoo. 2007. *Book of Universal Design*. 4

## How to solve the problem?

A boy using wheelchair enrolls at a primary school in his community.

He cannot participate in class activities because his class is located on the second floor.

**As a community or a principal, what can we do to solve this problem?**



5

## How to solve the problem?

- Refuse to enrol the boy at the school
  - Suggest a special school, without consultation with the boy and his family
- No equal basis with others/No freedom of choice  
**Attitudinal Barriers**

- Install a ramp at the school
  - Change the classroom to the ground floor
- Reasonable Accommodation**

- Install a lift at the school
  - All classrooms are located on the ground floor (= horizontal building design)
- Universal Design**

6



## Access to information and communication

### Video analysis



1. What is happening?
2. Why is it happening?
3. How do you solve the problem?

Note: The video is saved in the USB flash drives which is attached to the DEM guidelines. © Kuno, JICA, DET 7



## Persons with hearing impairments

### Deaf persons

- South African Sign Language (SASL) is their **first language**
- SASL is one of the **official languages** of South Africa

### Persons with hearing impairments and/or those who become deaf later in life:

- Might require access to **lip readers, note-takers and texting** because they have never used SASL.



8

## Persons with visual impairments

Text to be made available in alternative formats such as **Braille, large print, descriptions of graphs and pictures,** as well as in **audio** format



WPRPD (2015) 9

## Persons with speech impairments

- Ask the person again **clearly and gently** when you cannot understand them. (Avoid pretending you understand)
- Use **alternative and augmentative communication** to communicate and access information.

WPRPD (2015)



10



## Persons with intellectual impairments

Need **human support to meet their needs** and required tailored and innovative information and communication interventions and support services, such as easy-to-read materials.

WPRPD (2015)



Picture card



Photo



Gesture

11



## Access to transport

### Tips for changing attitudes and behaviour

- **Communicate with driver and express yourself**
- **Explain what kind of support you need**
- **Create a good relationship with drivers (don't complain or make demands but appreciate their support)**



12

# Voice of persons with disabilities

(Watch a video)



Note: The video is saved in the USB flash drives which is attached to the DEM guidelines.

13

## Wheelchair-accessible van (with a ramp or powered lift)



14



# Access to the built environment

## South African National Standards (SANS) 10400-S :

The application of the National Building Regulations document, published in 2011.

### SANS 10400-S:

The application of the National Building Regulations Part S:

**Facilities for persons with disabilities**



15



## Requirements: SANS 10400-S

- **General**
- **Signage**
- **Parking**
- **External and internal circulation**
- **Floor or ground surfaces**
- **Doorways, doors and door handles**
- **Changes in level**
- **Ramps**
- **Stairways**
- **Handrails**
- **Lifts**
- **Toilet facilities**
- **Auditoriums, grandstands and halls**
- **Controls, switches and power points**
- **Warning signals**
- **Lighting**

16



## Minimum mobility space for wheelchair

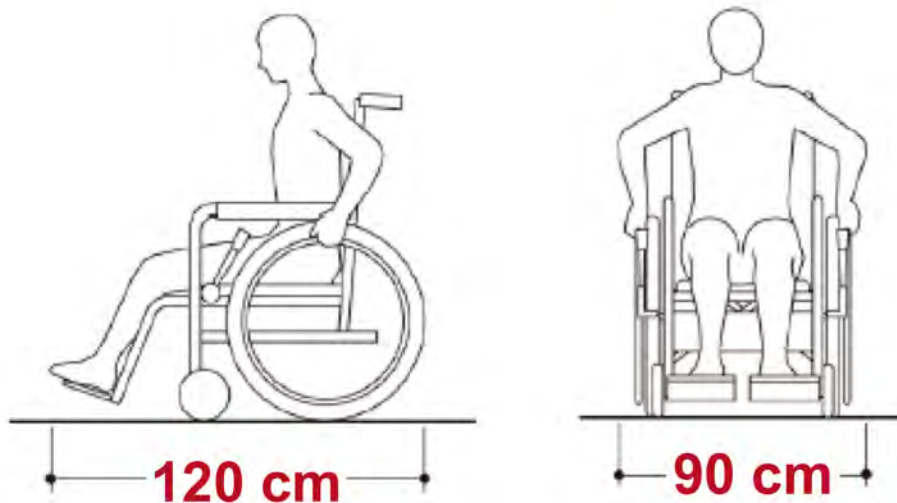

Source for graphic: The design manual of the accessibility code of the Tokyo Metropolitan Government 17

## Basic information: Width of passage

The width of **entrances** for a wheelchair should be more than 90 cm.

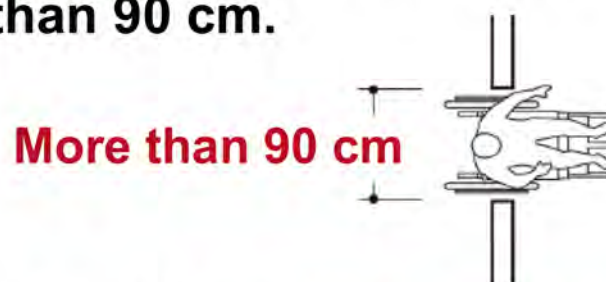

The clearance width of the **walking surfaces** should be more than 90 cm.



Source for graphic: The design manual of the accessibility code of the Tokyo Metropolitan Government 18

## Minimum mobility space of wheelchair

Remember! More than **90 cm** wide



19



## Signage

- Well located to be easily visible
- Adequate size and type of font to be read easily
- Contrasting light and dark colours
- Clear information



20

## Accessible signage for persons with visual impairment

To enable persons with low vision to read location signage next to doors or directional **signage on walls**, the signs should be placed at a height between **1.4 – 1.7 m** above finished floor level.



## Accessible signage for persons with visual impairment

**Hanging signs** must have a clearance of more than **2 m above** the trafficable surface.

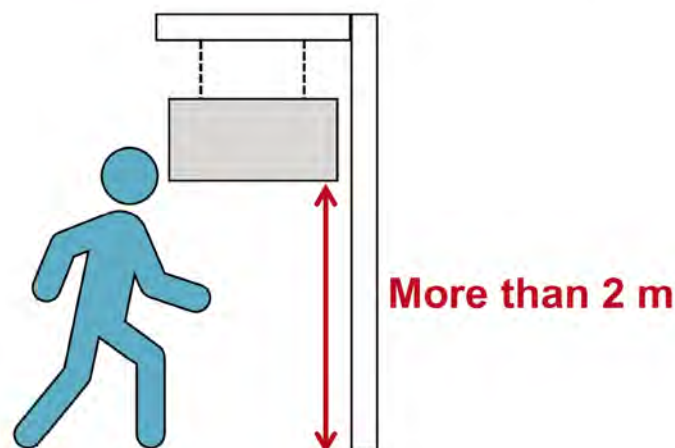



# Accessible signage for persons with low vision

## Enlarge letters



## Brightness and contrast



23



## External and internal circulation

- **At least one accessible route** should be provided from accessible parking spaces and public streets to the building entrance, and to the facilities inside the building.
- Accessible routes should be considered among the road, parking, entrance, toilet, ramp, lift and rooms.

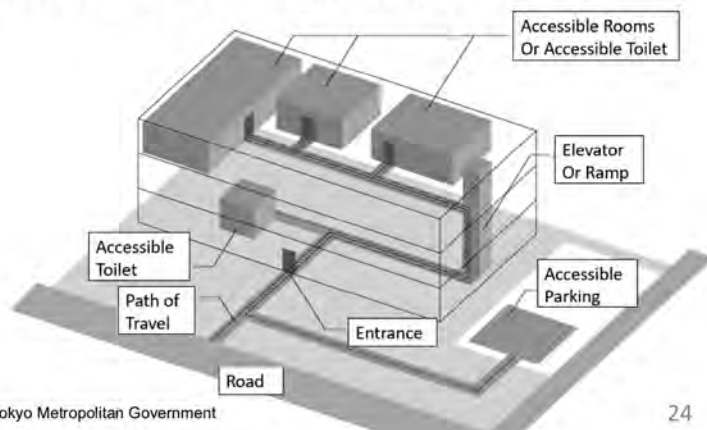

Source for graphic: The design manual of the accessibility code of the Tokyo Metropolitan Government

24

## External and internal circulation

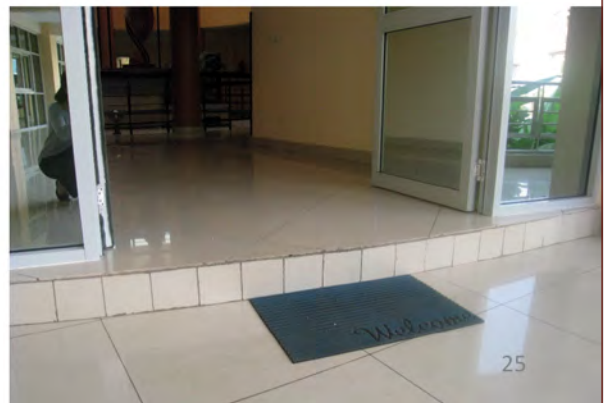

## External and internal circulation: Obstructions in the path of travel

Wall-mounted fire extinguishers, hose reels, telephones, litter bins and any other wall-mounted fittings should:

- be designed to be **seen easily**
- be shielded or recessed to **prevent injuries**.



26



# Parking

## Accessible parking spaces:

- Length: Not less than **4.5 – 5 m**
- Width: Not less than **3.5 m**
- **Located within 50 m** of an accessible entrance



27

## Is the parking accessible?



28

# Ramp

- **Gradient:** Not steeper than **1:12**
- **Surface:** Must be **stable, firm and slip-resistant**

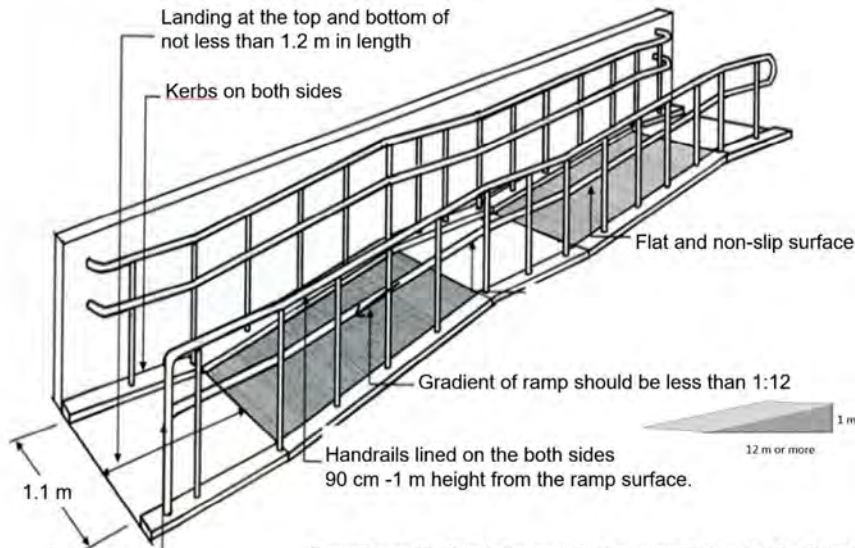
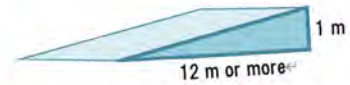

Source for graphic: The design manual of the accessibility code of the Tokyo Metropolitan Government 29

# Ramp

- **Wide:** More than **1.1 m**
- **Must have handrails on both sides** of the ramp. The height is top of a handrail from the surface of a ramp should be in range 90 cm to 1 m.



30



# Ramp

Landing at the top and bottom:  
More than **1.2 m** in length

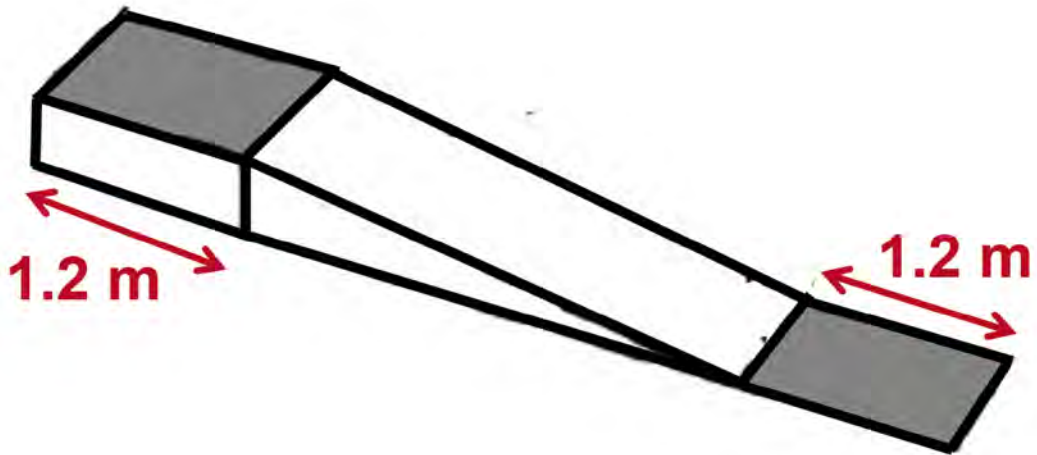

31



## Is the ramp accessible?



32

# Importance of gradient

Remember! Not steeper than **1:12**

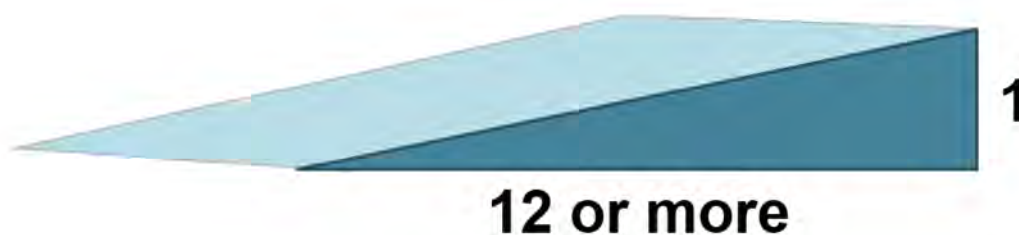

33

## How to use a ramp gradient finder

1. Put the ground connection side on the ramp surface.
  2. Note the string location in the area of the gradient criterion (1:12)
- When the string is located in the **GREEN** area, it complies with the criterion of 1:12
  - When the string is located in the left area (left-leaning), the ramp gradient is steeper than the criterion.

**SIMPLIFIED RAMP GRADIENT FINDER**

© Created by the Foundation for Promoting Personal Mobility and Ecological Transportation (Fonemob) - Fundación para el Fomento del Movimiento Personal y el Transporte Ecológico (Fonemob) - Fundación para el Fomento del Movimiento Personal y el Transporte Ecológico (Fonemob) - Fundación para el Fomento del Movimiento Personal y el Transporte Ecológico (Fonemob)

\* Make sure to align the ground connection side below with the edge of the cardboard.

Now: The finder was assessed for the (purposeful) monitoring possibility of facilities by access auditors.

**[How to make the FINDER]**

1. Photocopy this page (about A4 size).
2. Attach the copy to a piece of cardboard cut to the same size.  
\* Make sure to align the ground connection side below with the edge of the cardboard.
3. Prepare a piece of string (about 27 cm length).
4. Make a pinhole at the small O in the upper right corner.  
\* Put the string through the hole and tape it up.
5. Attach a perforated coin (e.g. 20 cent coin) to the other end of the string.

Done and ready to measure RAMP GRADIENT!

**[How to measure the RAMP GRADIENT]**

1. Put the ground connection side on the ramp surface.
2. Note the string location in the area of the gradient criterion (1:12)

- When the string is located in the **GREEN** area, it complies with a criterion of 1:12.
- When the string is located in the left area (left-leaning), the ramp gradient is steeper than the criterion.

**Ground Connection Side**  
Put this side on the ramp surface.

**1:12**

The diagram shows a vertical green triangle on the right side of a white background. A string is attached to a yellow coin at the top right corner and runs down the left side of the green triangle. The green triangle is labeled '1:12' at its base. Below the green triangle, there is a yellow circle with a string attached to it, and a label 'Ground Connection Side' with arrows pointing to the bottom edge of the green triangle.

34



# Ramp Gradient Finder

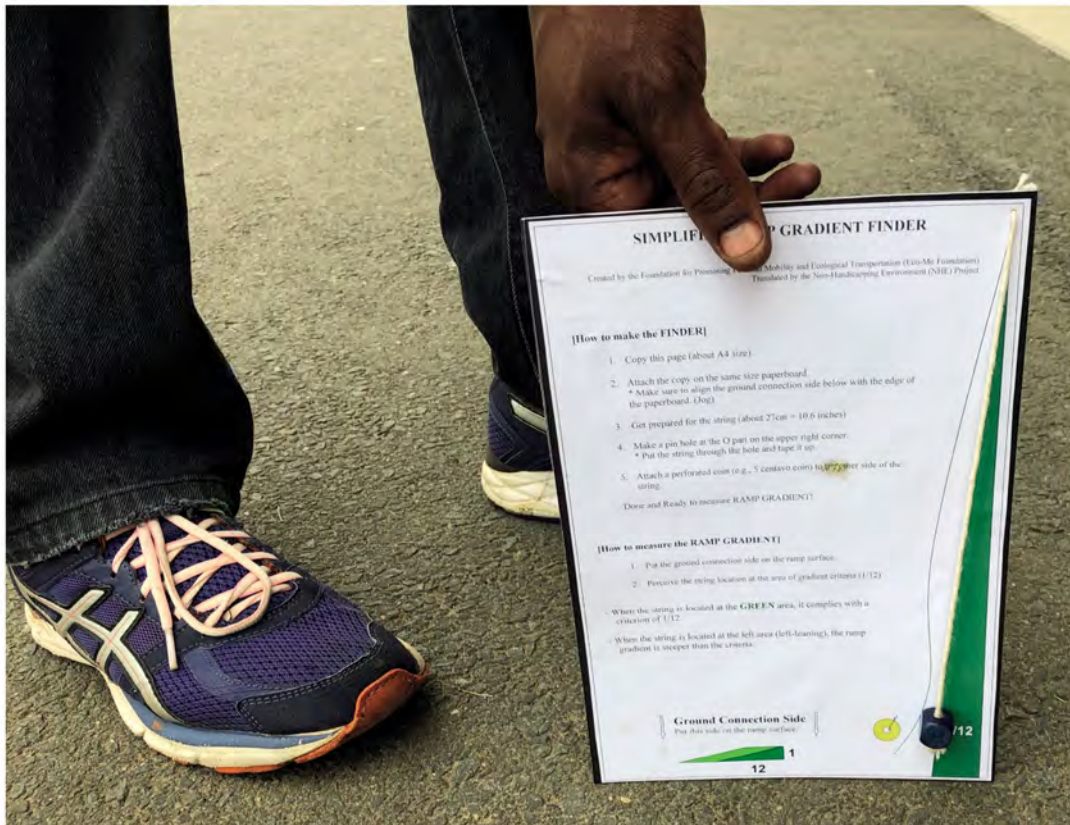

35



# Stairways

- Must be have **handrails on both sides** of the stairway
- **Contrast:** The edges of the treads must be delineated by a contrasting colour, i.e. different from the colour of the remainder of the treads.
- **Length:** More than 90 cm
- **Height:** Less than 17 cm
- **Width:** More than 28cm

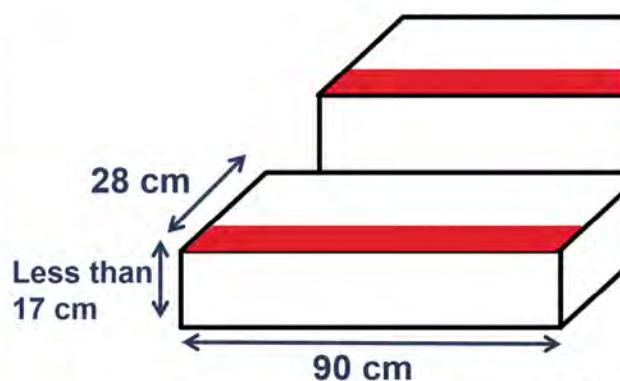

36



## Handrail

- Handrail provided on both sides
- Height: Top of a handrail from the surface of a ramp should be in range 90 cm to 1 m

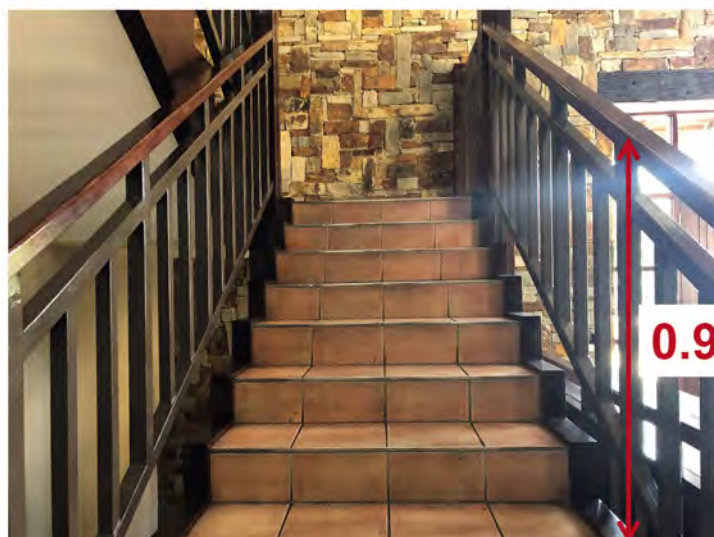

37

**Is this toilet accessible for wheelchair users?**



38

## Wheelchair-accessible toilet: Door

- Should open outwards
- Have a clear opening of more than 90 cm



Source for graphic: The design manual of the accessibility code of the Tokyo Metropolitan Government 39



## Wheelchair-accessible toilet: Space

Minimum wall-to-wall dimensions of the toilet should be more than 1.8 m x 1.8 m.

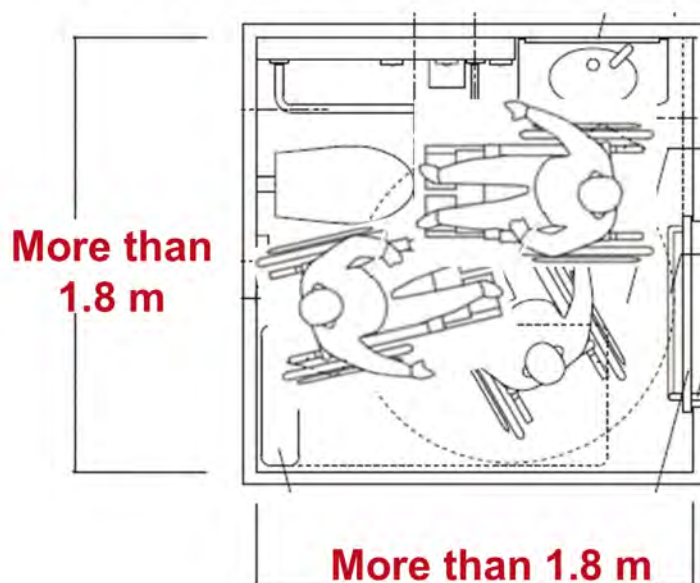

Check whether the toilet compartment has enough space for maneuvering



Source for graphic: The design manual of the accessibility code of the Tokyo Metropolitan Government

40



## Wheelchair-accessible toilet: Space

To enable transfer from a wheelchair to the toilet seat, there must be sufficient space next to the toilet bowl.

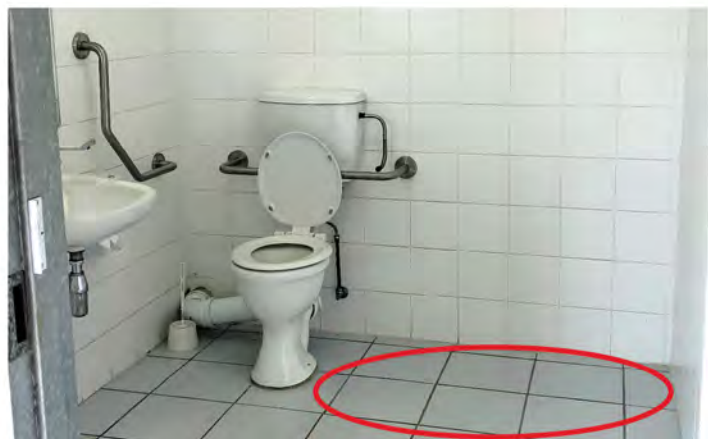
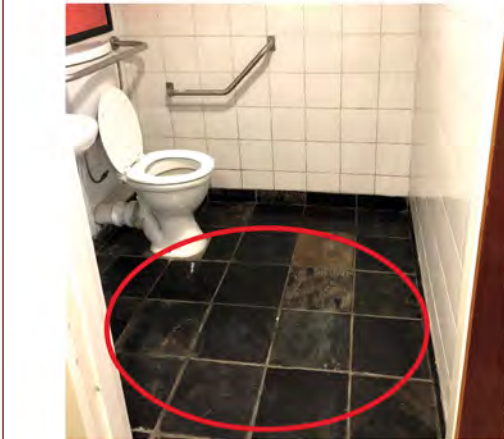

## Wheelchair-accessible toilet: Height of toilet seat

Top surface of the toilet seat should be in the range 48 – 50 cm from floor level.



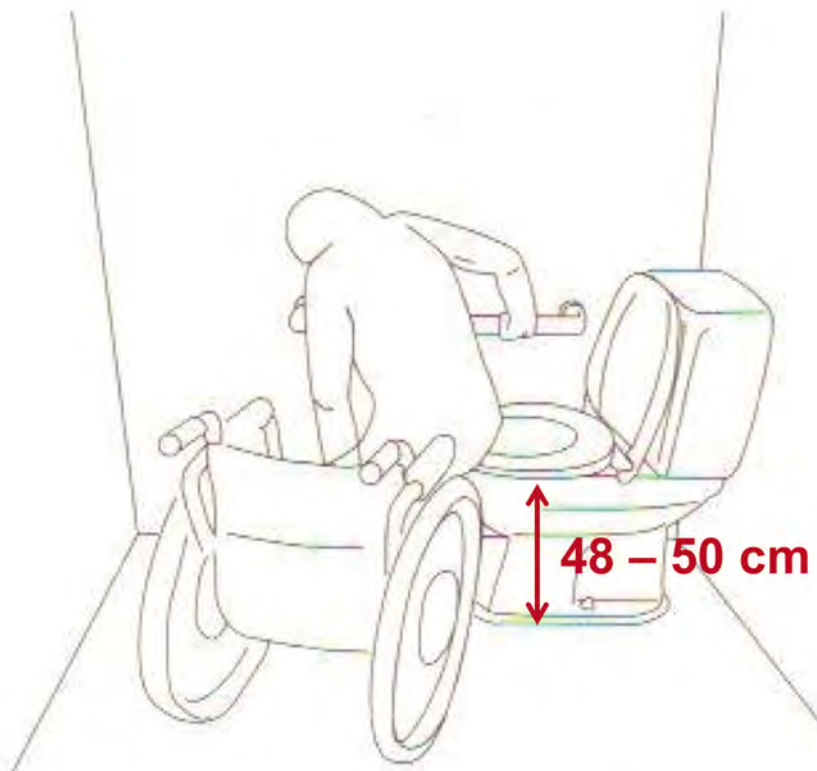

Source for graphic: The design manual of the accessibility code of the Tokyo Metropolitan Government 43



## Wheelchair-accessible toilet: Grab rails

- Suitable grab rails should be fixed to the side wall and the rear wall.
- The height of the grab rail is 74 cm (between the grab rail and floor level).
- The centre line of the toilet should be in the range 45–50 cm from the nearside wall.



44

# Checklist for Access Audit

**MATERIALS ON ACCESS AUDITOR TRAINING:  
ACCESS AUDIT CHECKLIST**



**TOOL 15-2**

The checklist was developed by the OSD/IICA project for the purpose of monitoring accessibility and usability of facilities, based mainly on the South African National Standards (SANS) 10400, the Building Regulations.





Name of facility: \_\_\_\_\_ Date: \_\_\_\_/\_\_\_\_/\_\_\_\_

Location of facility: \_\_\_\_\_ Municipality: \_\_\_\_\_

Ward: \_\_\_\_\_ District: \_\_\_\_\_ Province: \_\_\_\_\_

Representative name of the access audit team: \_\_\_\_\_

Places of access audit: \_\_\_\_\_  
e.g. parking, entrance of the building, toilets, meeting room, etc.

QUESTIONS	GUIDE	YES	NO
<b>1 EXTERNAL CIRCULATION (from street to an entrance of the building)</b>			
1.1 Is the footway width more than 90 cm?		<input type="checkbox"/>	<input type="checkbox"/>
1.2 Does the route have step-free access?		<input type="checkbox"/>	<input type="checkbox"/>
1.3 Is the route clear of hazardous objects so that persons with visual impairment avoid injuring themselves, and can move easily?		<input type="checkbox"/>	<input type="checkbox"/>
<b>2 PARKING</b>			
2.1 Is there accessible parking? Size: More than 4.5 m length x 3.5 m width		<input type="checkbox"/>	<input type="checkbox"/>
2.2 Is the parking space clearly marked with both on-road symbols and vertical signs, and easy to find?		<input type="checkbox"/>	<input type="checkbox"/>
2.3 Is the parking located within 50 m of an accessible entrance?		<input type="checkbox"/>	<input type="checkbox"/>
2.4 Is there a step-free and safe route to the entrance of the building from the parking area?		<input type="checkbox"/>	<input type="checkbox"/>

45

## Remember!

- **Minimum mobility space of wheelchair:** 90 cm width



- **Signage:** Contrasting light and dark colours to see clearly



- **Hanging signs:** Have a clearance of more than 2 m above the trafficable surface.

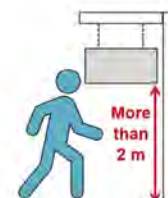

- **Ramp gradient:** Not steeper than 1:12



46



## Remember!

- **Toilet door:** Open outwards
- **Toilet space:** 1.8 m x 1.8 m
- **Height of toilet seat:** 48–50 cm from the floor level

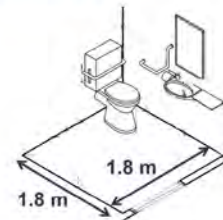
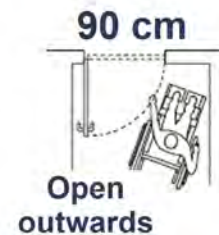

47



## What is an access audit?

- Examining the accessibility and ‘usability’ of facilities and services
- Identifying barriers and considering means of eliminating or mitigating them
- Deals not only with **physical barriers** but also **information, legislative and attitudinal barriers**

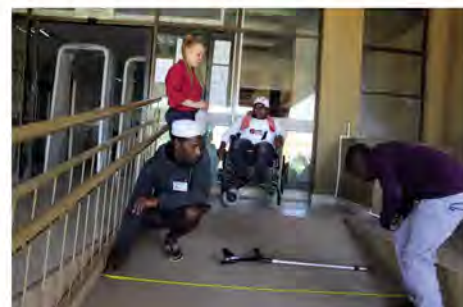

48

# Access audit for whom?

- Considers accessibility and usability for persons **with various types of impairment**.
- This consideration contributes to making facilities and services more usable **for all members of society**, including pregnant women, older persons, children, etc.



Source for graphic: Kenichiro Miyairi & Yoshie Yokoo. 2007. *Book of Universal Design*.

49

# Access audit by whom?

Conducted as a team consisting of:

- Persons with various types of impairment
- Specialists like architects and civil engineers
- Government officials (e.g. DSD, Public Works)
- Stakeholders of facilities/services of the access audit



50



# Access audit team

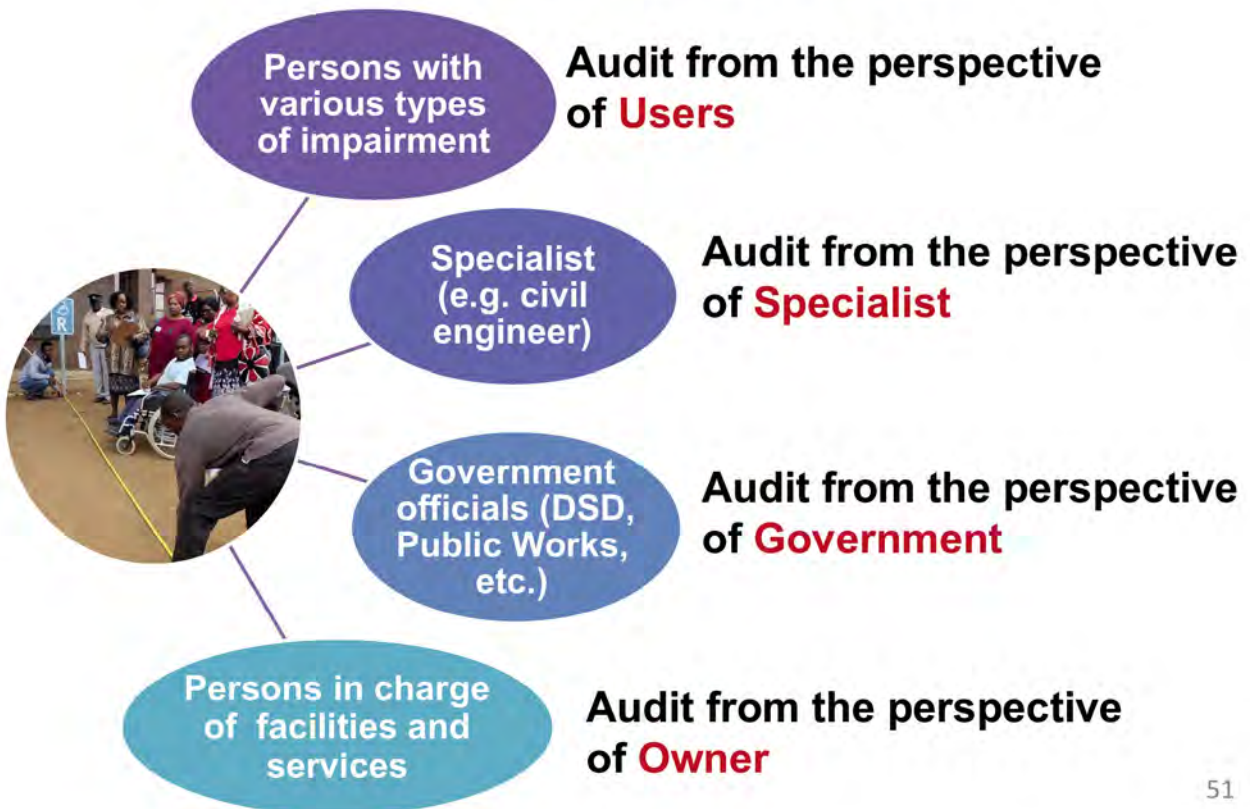

51



# Seven steps for the access audit



52

## **Step 1: Identify needs**

- **What facilities and services need an access audit?**
- **What are the problems?**
- **Why have the problems happened?**

53

## **Step 2: Obtain approval**

- **Communicate with the management of facilities/services to get approval for the access audit**
- **Invite DSD/municipal officials responsible for disability to the meeting with the facilities/services management**

54



## Step3: Establish access audit team

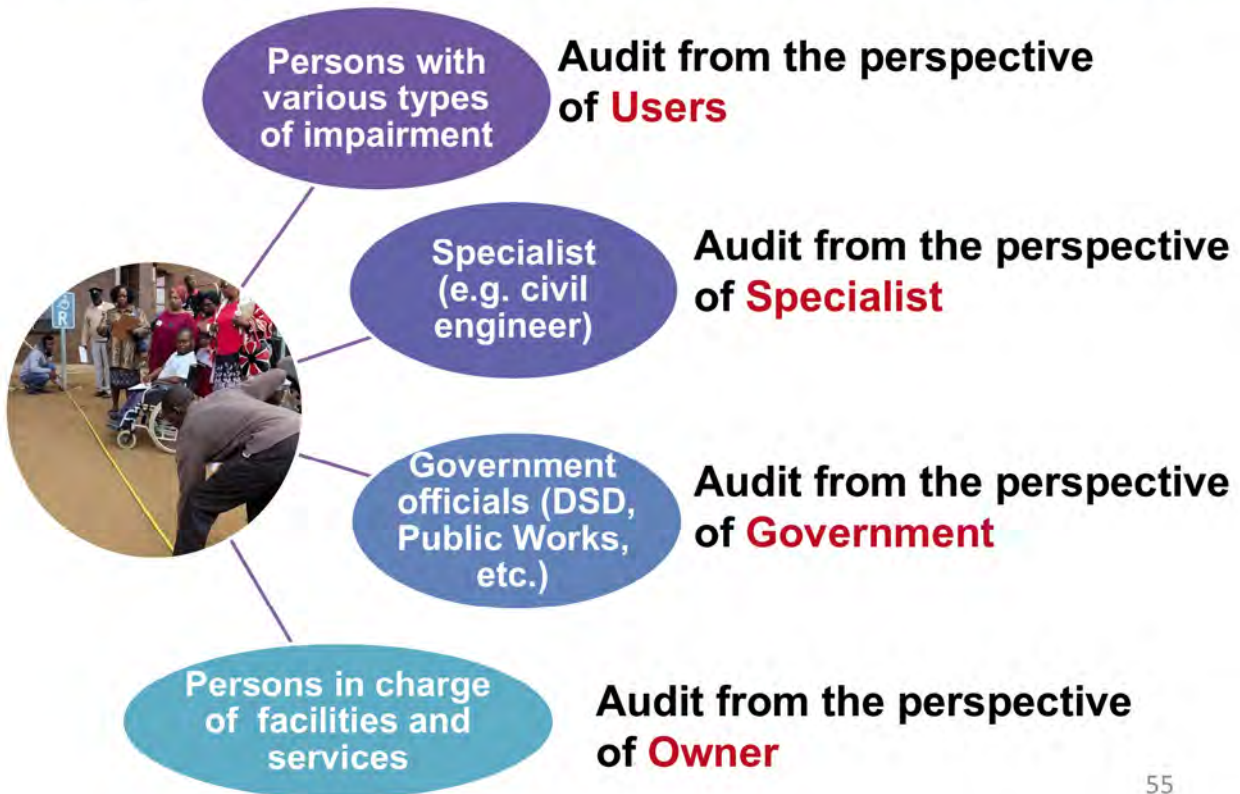

55



## Step 4: Develop access audit plan

- **Set a shared goal/objective**
- **Decide on focus areas of the access audit**
- **Design route/order and time schedule**
- **Allocate roles for each member**  
(e.g. coordinator among stakeholders, recorder, timekeeper, preparation equipment, etc.)
- **Prepare necessary equipment**  
(e.g. checklist, pens, tape measure, simplified ramp gradient finder, SANS documents, etc.)

56



# Step 5: Conduct access audit

Conduct access audit with the checklist.  
The roles of the members are:

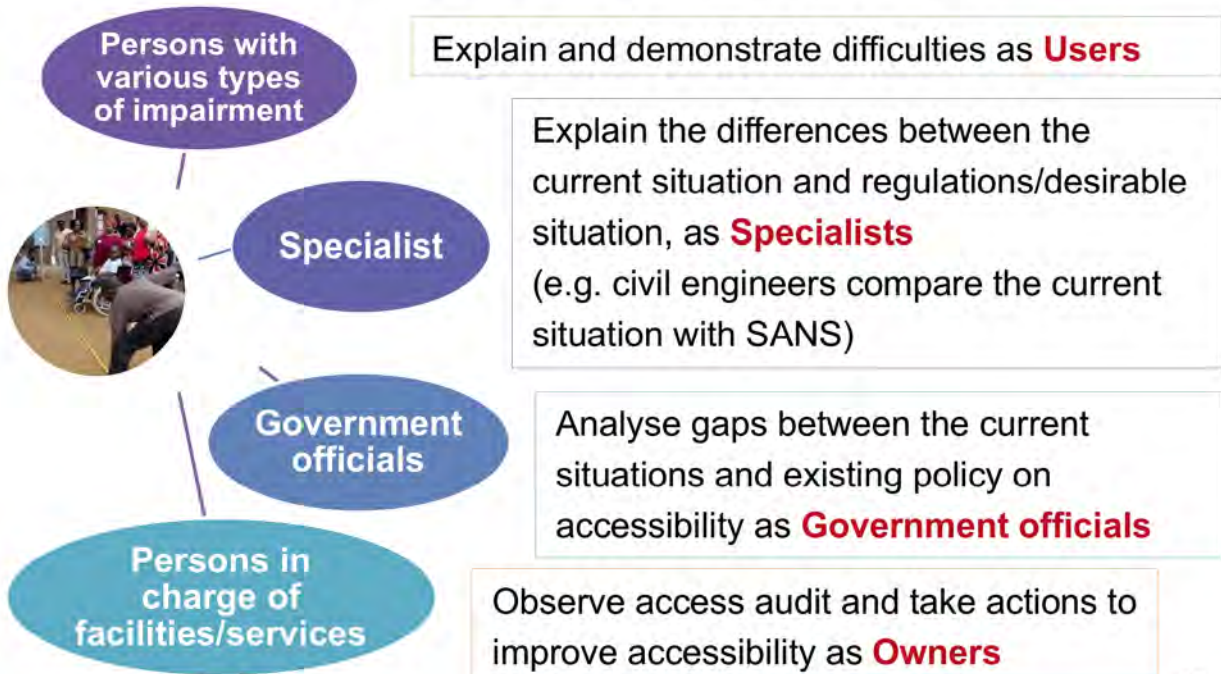

# Step 5: Conduct access audit

## Checklist for access audit

**MATERIALS ON ACCESS AUDITOR TRAINING: ACCESS AUDIT CHECKLIST** **TOOL 15-2**

The checklist was developed by the ESD/BCA project for the purpose of monitoring accessibility and usability of facilities, based mainly on the South African National Standards (SANS) 10400, the Building Regulations.

Name of facility: \_\_\_\_\_ Date: \_\_\_\_/\_\_\_\_/\_\_\_\_

Location of facility:  
Ward: \_\_\_\_\_ Municipality: \_\_\_\_\_  
District: \_\_\_\_\_ Province: \_\_\_\_\_

Representative name of the access audit team: \_\_\_\_\_

Places of access audit:  
e.g. parking, entrance of the building, toilets, meeting room, etc.

QUESTIONS	GUIDE	YES	NO
<b>1 EXTERNAL CIRCULATION (from stairs to an entrance of the building)</b>			
1.1 Is the footway width more than 90 cm?		<input type="checkbox"/>	<input type="checkbox"/>
1.2 Does the route have step-free access?		<input type="checkbox"/>	<input type="checkbox"/>
1.3 Is the route clear of hazardous objects so that persons with visual impairment avoid injuring themselves, and can move easily?		<input type="checkbox"/>	<input type="checkbox"/>
<b>2 PARKING</b>			
2.1 Is there accessible parking? Size: More than 4.5 m length x 3.5 m width		<input type="checkbox"/>	<input type="checkbox"/>
2.2 Is the parking space clearly marked with both on-road symbols and vertical signs, and easy to find?		<input type="checkbox"/>	<input type="checkbox"/>
2.3 Is the parking located within 50 m of an accessible entrance?		<input type="checkbox"/>	<input type="checkbox"/>
2.4 Is there a step-free and safe route to the entrance of the building from the parking area?		<input type="checkbox"/>	<input type="checkbox"/>

## Step 6: Develop a recommendation report

ACCESS AUDIT REPORT TEMPLATE

Place: \_\_\_\_\_ Audit date: \_\_\_\_/\_\_\_\_/\_\_\_\_

Audit team member's name: \_\_\_\_\_

H/M/L: High/Medium/Low

NO.	AREA OF FACILITIES/SERVICES	CURRENT SITUATION (PROBLEMS)	RECOMMENDATIONS	PRIORITY		COST	
				H/M/L	H/M/L	H/M/L	H/M/L
1							
2							
3							
4							
5							
6							

- Areas of facilities and services
- Current situation (problems)
- Recommendations
- Priority (High/Medium/Low)
- Cost (High/Medium/Low)



59

## Step 6: Develop a recommendation report

### Example of a report

No.	Area of facilities/services	Current situation (problems)	Recommendations	Priority	Cost
				H/M/L	H/M/L
1	Footways from street to the entrance of the building	Litter bins fell over and all the trash spilled out.	Keep the route clear of hazardous objects so that persons with visual impairments avoid injuring themselves.	H	L
2	Parking	There is no accessible parking.	Provide accessible parking spaces (size: 4.5 m x 3.5 m) located within 50 m of the entrance.	M	M
3	Entrance	There is no step-free access at the entrance.	Install an appropriate ramp based on SANS	H	M
4	Reception	There are no staff or information counter to support visitors and users.	Prepare staff and an information counter with good signage.	H	M
5	Toilets	There is no wheelchair-accessible toilet.	Provide a wheelchair-accessible toilet based on SANS	H	H

60



## Step 7: Monitoring and follow-up

- Monitoring and follow-up are recommended to be conducted **within one month** after submission of the report
- Monitor progress and **analyse the challenges and needs** if it has not progressed
- **Take necessary action** to solve the challenges



61

## Tips for a good access audit

- Deal with **attitudinal and information barriers** as well as physical barriers
- Consider not only your own impairment but also **various other types of impairment**
- Don't be a complainer; instead be **a supporter** to improve facilities/services (always use polite language)
- Know **the basic information on the legislative framework**
- **Involve persons in charge of facilities/services** from the planning to the monitoring stages
- **Continually monitor and follow up** to improve accessibility (an access audit is not a one-time activity)

62

# Access audit practice

## Preparation for access audit

- Design a route/order
- Decide on focus areas of the access audit
- Design a time schedule
- Allocate roles for each member

Checklist

Time management

Measurement

Simplified ramp gradient finder

Recommendation report

63



## Focus areas of the access audit

**MATERIALS ON ACCESS AUDITOR TRAINING: ACCESS AUDIT CHECKLIST** **TOOL 15-2**

The checklist was developed by the DSD/JICA project for the purpose of monitoring accessibility and usability of facilities, based mainly on the South African National Standards (SANS) 10400, the Building Regulations.

Name of facility: \_\_\_\_\_ Date: / /

Location of facility:  
Ward: \_\_\_\_\_ Municipality: \_\_\_\_\_  
District: \_\_\_\_\_ Province: \_\_\_\_\_

Representative name of the access audit team: \_\_\_\_\_

Places of access audit:  
e.g. parking, entrance of the building, toilets, meeting room, etc.

### Places of the access audit (example):

Parking → Entrance of the building →

Toilets → Meeting room

64





## TOOL 15-1

### MATERIALS ON ACCESS AUDITOR TRAINING: SIMPLIFIED RAMP GRADIENT FINDER

#### SIMPLIFIED RAMP GRADIENT FINDER

Created by the Foundation for Promoting Personal Mobility and Ecological Transportation (Eco-Mo Foundation)  
Translated by the Non-Handicapping Environment (NHE) Project, JICA

Note: The finder was developed for the purpose of monitoring accessibility of facilities by access auditors.

##### [How to make the FINDER]

1. Photocopy this page (about A4 size).
2. Attach the copy to a piece of cardboard cut to the same size.  
\* Make sure to align the ground connection side below with the edge of the cardboard.
3. Prepare a piece of string (about 27 cm length).
4. Make a pinhole at the small O in the upper right corner.  
\* Put the string through the hole and tape it up.
5. Attach a perforated coin (e.g. 20 cent coin) to the other end of the string.

Done and ready to measure RAMP GRADIENT!

##### [How to measure the RAMP GRADIENT]

1. Put the ground connection side on the ramp surface.
  2. Note the string location in the area of the gradient criterion (1:12).
- When the string is located in the **GREEN** area, it complies with a criterion of 1:12.
  - When the string is located in the left area (left-leaning), the ramp gradient is steeper than the criterion.

↓ **Ground Connection Side** ↓  
Put this side on the ramp surface.



1:12



# MATERIALS ON ACCESS AUDITOR TRAINING: ACCESS AUDIT CHECKLIST

## TOOL 15-2

The checklist was developed by the DSD/JICA project for the purpose of monitoring accessibility and usability of facilities, based mainly on the South African National Standards (SANS) 10400, the Building Regulations.

Name of facility: \_\_\_\_\_ Date: \_\_\_\_ / \_\_\_\_ / \_\_\_\_

### Location of facility:

Ward: \_\_\_\_\_ Municipality: \_\_\_\_\_





District: \_\_\_\_\_ Province: \_\_\_\_\_



Representative name of the access audit team: \_\_\_\_\_



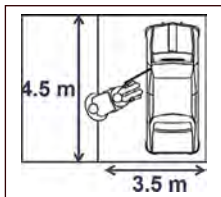
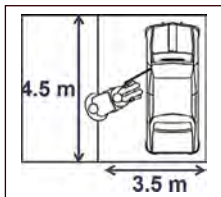
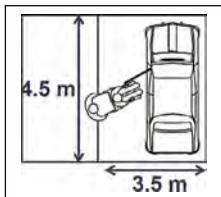

### Places of access audit:

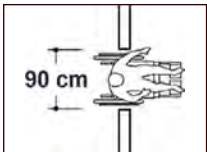
e.g. parking, entrance of the building, toilets, meeting room, etc.

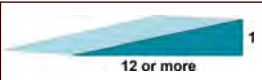
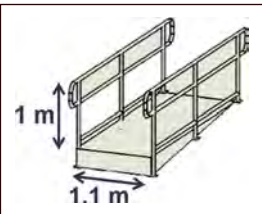
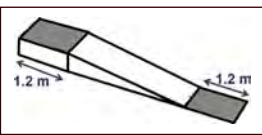



QUESTIONS		GUIDE	YES	NO
<b>1 EXTERNAL CIRCULATION (from street to an entrance of the building)</b>				
1.1	Is the footway width more than 90 cm?		<input type="checkbox"/>	<input type="checkbox"/>
1.2	Does the route have step-free access?		<input type="checkbox"/>	<input type="checkbox"/>
1.3	Is the route clear of hazardous objects so that persons with visual impairment avoid injuring themselves, and can move easily?		<input type="checkbox"/>	<input type="checkbox"/>
<b>2 PARKING</b>				
2.1	Is there accessible parking? Size: More than 4.5 m length x 3.5 m width		<input type="checkbox"/>	<input type="checkbox"/>
2.2	Is the parking space clearly marked with both on-road symbols and vertical signs, and easy to find?		<input type="checkbox"/>	<input type="checkbox"/>
2.3	Is the parking located within 50 m of an accessible entrance?		<input type="checkbox"/>	<input type="checkbox"/>
2.4	Is there a step-free and safe route to the entrance of the building from the parking area?		<input type="checkbox"/>	<input type="checkbox"/>

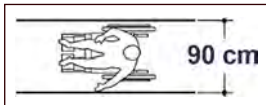

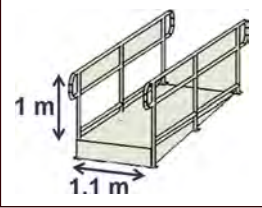
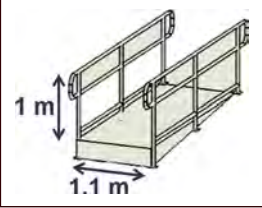
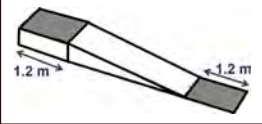

QUESTIONS	GUIDE	YES	NO
<b>3 ENTRANCE</b>			
3.1 Is the entrance easy to identify with good signage and visual contrast?		<input type="checkbox"/>	<input type="checkbox"/>
3.2 Is the width of the entrance (and the entrance door) more than 90 cm?		<input type="checkbox"/>	<input type="checkbox"/>
3.3 If there is a door, is the door handle easy to operate and reach at a suitable height (1 m from the floor)?		<input type="checkbox"/>	<input type="checkbox"/>
3.4 Is there step-free access?		<input type="checkbox"/>	<input type="checkbox"/>
<p>If there is a ramp, answer the following questions from 3.5 to 3.9.          If there is no ramp, please go to the question 3.10.</p>			
3.5 Is the ramp gradient no steeper than 1:12 ?		<input type="checkbox"/>	<input type="checkbox"/>
3.6 Is the ramp width more than 1.1 m?		<input type="checkbox"/>	<input type="checkbox"/>
3.7 Are there handrails on both sides at a suitable height (0.9 m–1 m) and easy to grip?		<input type="checkbox"/>	<input type="checkbox"/>
3.8 Is the ramp surface slip-resistant?		<input type="checkbox"/>	<input type="checkbox"/>
3.9 Are the ramp landing areas more than 1.2 m in length?		<input type="checkbox"/>	<input type="checkbox"/>
<p>If the facility is difficult to get into for persons with disabilities, what assistance is provided?          Answer the following questions:</p>			
3.10 Is there an alternative accessible entrance?		<input type="checkbox"/>	<input type="checkbox"/>
3.11 Are there staff present to offer assistance?		<input type="checkbox"/>	<input type="checkbox"/>
3.12 Other (specify: _____ )			

QUESTIONS		GUIDE	YES	NO
<b>4 RECEPTION/SERVICE COUNTER</b>				
4.1	Is there good signage to identify the reception/service counter from the entrance?	 	<input type="checkbox"/>	<input type="checkbox"/>
4.2	Are there staff to offer assistance to persons with disabilities?			
4.3	Are there staff to provide various communication ways for persons with hearing impairment if the person requests it? Example: Sign language, writing and clear speech (for lip readers)			
4.4	Are there services for persons with visual impairment to obtain the necessary information if the person requests it? Example: Braille documents and reading documents aloud			
4.5	Do staff talk gently, simply and repeat things for persons who have difficulties with communication, such as persons with intellectual impairment?		<input type="checkbox"/>	<input type="checkbox"/>
4.6	Are staff trained in how to assist persons with various types of impairment?		<input type="checkbox"/>	<input type="checkbox"/>
<b>5 SIGNAGE (internal)</b>				
5.1	Is the signage clear and simple, and: <ul style="list-style-type: none"> <li>Well located to see easily</li> <li>Contrasting light and dark colours</li> <li>Clear information</li> <li>Adequate size and type of font to be read easily?</li> </ul>	 	<input type="checkbox"/>	<input type="checkbox"/>
<b>6 INTERNAL CIRCULATION (from entrance to each room)</b>				
6.1	Is the route clear of hazardous objects so that persons with visual impairment avoid injuring themselves, and can move easily?		<input type="checkbox"/>	<input type="checkbox"/>
6.2	Are there corridors or aisles with widths of more than 90 cm so that wheelchair users, walker- or crutches users can move easily along the aisles?		<input type="checkbox"/>	<input type="checkbox"/>
6.3	Is there step-free access to the different levels via a ramp or lift?		<input type="checkbox"/>	<input type="checkbox"/>

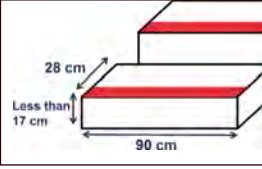

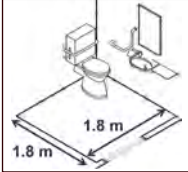
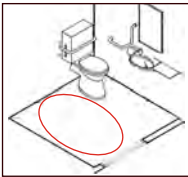

QUESTIONS	GUIDE	YES	NO
If there is a ramp, answer the following questions:			
6.4 Is the ramp gradient not steeper than 1:12?		<input type="checkbox"/>	<input type="checkbox"/>
6.5 Is the ramp width more than 1.1 m?		<input type="checkbox"/>	<input type="checkbox"/>
6.6 Is the ramp surface slip-resistant?		<input type="checkbox"/>	<input type="checkbox"/>
6.7 Are there handrails on both sides at a suitable height (0.9–1 m) that are easy to grip?		<input type="checkbox"/>	<input type="checkbox"/>
6.8 Are the ramp landing areas more than 1.2 m in length?		<input type="checkbox"/>	<input type="checkbox"/>
If there is a lift, answer the following questions:			
6.9 Is there clear signage that makes it easy to locate?		<input type="checkbox"/>	<input type="checkbox"/>
6.10 Is the lift maintained and managed well?		<input type="checkbox"/>	<input type="checkbox"/>
6.11 Can the lift be operated easily by persons with various types of impairment?		<input type="checkbox"/>	<input type="checkbox"/>
<b>7 STAIRWAYS</b>			
7.1 Are there handrails on both sides at a suitable height (0.9 m–1 m), and easy to grip?		<input type="checkbox"/>	<input type="checkbox"/>
7.2 Are there slip-resistant edges to each step?		<input type="checkbox"/>	<input type="checkbox"/>
7.3 Are the edges of the treads delineated by a contrasting colour, different from the colour of the remainder of the tread?		<input type="checkbox"/>	<input type="checkbox"/>
7.4 Is the length of each step more than 90 cm?		<input type="checkbox"/>	<input type="checkbox"/>
7.5 Is the width of each step more than 28 cm?		<input type="checkbox"/>	<input type="checkbox"/>
7.6 Is the height of each step less than 17 cm?		<input type="checkbox"/>	<input type="checkbox"/>

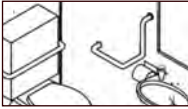
QUESTIONS		GUIDE	YES	NO
<b>8 TOILETS</b>				
8.1	Is there a wheelchair-accessible toilet?		<input type="checkbox"/>	<input type="checkbox"/>
If there is no wheelchair accessible toilet, answer the following questions on the general toilet:				
8.2	Is there good signage to find where the toilet is located?		<input type="checkbox"/>	<input type="checkbox"/>
8.3	Are there step-free accessible routes to get to the toilets from the different levels?		<input type="checkbox"/>	<input type="checkbox"/>
8.4	Does the toilet have an outward-opening door?		<input type="checkbox"/>	<input type="checkbox"/>
8.5	Does the door into the toilet have a clearance opening of more than 90 cm?		<input type="checkbox"/>	<input type="checkbox"/>
8.6	Is the door handle of the toilet easy to operate and reach at a suitable height (1 m from the floor)?		<input type="checkbox"/>	<input type="checkbox"/>
8.7	Are the wall-to-wall dimensions of the toilet more than 1.8 m x 1.8 m?		<input type="checkbox"/>	<input type="checkbox"/>
8.8	Is there enough space next to the toilet bowl to transfer from a wheelchair to the toilet seat?		<input type="checkbox"/>	<input type="checkbox"/>
8.9	Is the height of the toilet seat in the range from 48 cm to 50 cm (between the top of the toilet seat and the floor level)?		<input type="checkbox"/>	<input type="checkbox"/>
8.10	Is a grab rail provided on the wall side of the toilet?		<input type="checkbox"/>	<input type="checkbox"/>

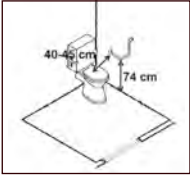

QUESTIONS	GUIDE	YES	NO
If there is a grab rail, answer the following questions:			
<p><b>8.11</b> Is the height of the grab rail 74 cm (between the grab rail and the floor level)?</p>		<input type="checkbox"/>	<input type="checkbox"/>
<p><b>8.12</b> Is the distance of the grab rail location in a range from 40 cm – 45 cm (between the centre line of the toilet and the grab rail)?</p>		<input type="checkbox"/>	<input type="checkbox"/>

**Other findings, recommendations, remarks**



## ACCESS AUDIT REPORT

Place: \_\_\_\_\_

Audit date: \_\_\_\_ / \_\_\_\_ / \_\_\_\_

Audit team member's name: \_\_\_\_\_

H/M/L: High/Medium/Low



NO.	AREA OF FACILITIES/SERVICES	CURRENT SITUATION (PROBLEMS)	RECOMMENDATIONS	PRIORITY	COST
				H/M/L	H/M/L
1	e.g. Footways from street to the entrance of the building	Litter bins fell over and all the trash spilled out.	Make the route clear of hazardous objects so that persons with visual impairments avoid injuring themselves.	H	L
2	e.g. Parking	There is no staff and information counter to support persons.	Provide a staff and information counter with good signage.	M	M
3	e.g. Entrance	There is no step-free access in the entrance.	Install an appropriate ramp based on SANS	H	M
4	e.g. Toilets	There is no wheelchair-accessible toilet.	Make a wheelchair-accessible toilet based on SANS	H	H
5					
6					





Design and layout: Ink Design Publishing Solutions  
[www.inkdesign.co.za](http://www.inkdesign.co.za)

Printing: XXXX

Enquiries: Chief Directorate Communication

134 Pretorius Street Pretoria, Gauteng South Africa

Department of Social Development Private Bag X901  
Pretoria, Gauteng Republic of South Africa, 0001

Tel: +27 12 312 7653

Fax: +27 12 312 7988

Toll Free Number: 0800 60 1011

Website: [www.dsd.gov.za](http://www.dsd.gov.za)

